



List Price Book

Effective July 8, 2013



About Us

Jomar Group and our partner F. Pettinaroli SPA., an ISO-EN-9001 registered facility has been a leading supplier of innovative valve and component solutions since 1966. Our competitively priced products are available for purchase throughout North and South America by way of the company's wholesale distribution network and specialized representatives. Jomar's corporate office, located in Warren, Michigan, markets a diverse line of industrial, utility, HVAC, and process control applications. More information on the company's notable achievements, services provided, and products can be found at www.jomar.com.

Dear Valued Customers and Friends,

Thank you for choosing Jomar Valve. At Jomar, we are passionate about producing the highest quality products for all of our customers throughout North America. For over 50 years, Jomar has been one of the leading suppliers of innovative valves and component solutions. Our expanding product line is designed for a variety of applications including plumbing, industrial, utility, HVAC, and process control. We are committed to providing not only quality products, but top of the line customer service, sales, marketing strategies, technology, and innovation.

As we continue to grow, we are conscious of our responsibility to improve in every area. With this in mind, we have created a brand new price book intended to meet and exceed all that is expected of us. We strive to be the best in our field and are confident to offer you nothing less.

Sincerely,
Paul Craig

New Products



p. 10

T-100NEG
Dezincification
Resistant Brass Valve



p. 22

T-100SSS
Rated for 250WSP



p. 31

T-204DU
with Male NPT
Tailpiece



p. 33

T-203DU
with Male NPT
Tailpiece



p. 46

T-SS-2000N-DH
with Spring Return
Handle

T-100NE

The Jomar T-100NE Features...

- Triple Stem Seal
- Geomet® Handle
- Hostaflon® Seats
- Hot forged brass
- Heavy body pattern
- 100% full port
- Blow-out proof two-piece design
- 100% made and tested in Italy



VQGU - Trim & drain
MHKZ - Manual valves
YQNZ - Compressed gas shut-off valves
YRBX - Flammable liquid shut-off valves
YRPV - Gas shut-off valves
YSDT - LP gas shut-off valves
SFJQ - Valves, refrigerant



Add-A-Valve®

In 30 minutes or less*, replace or repair a defective valve or pipe, add a line or isolate an area.

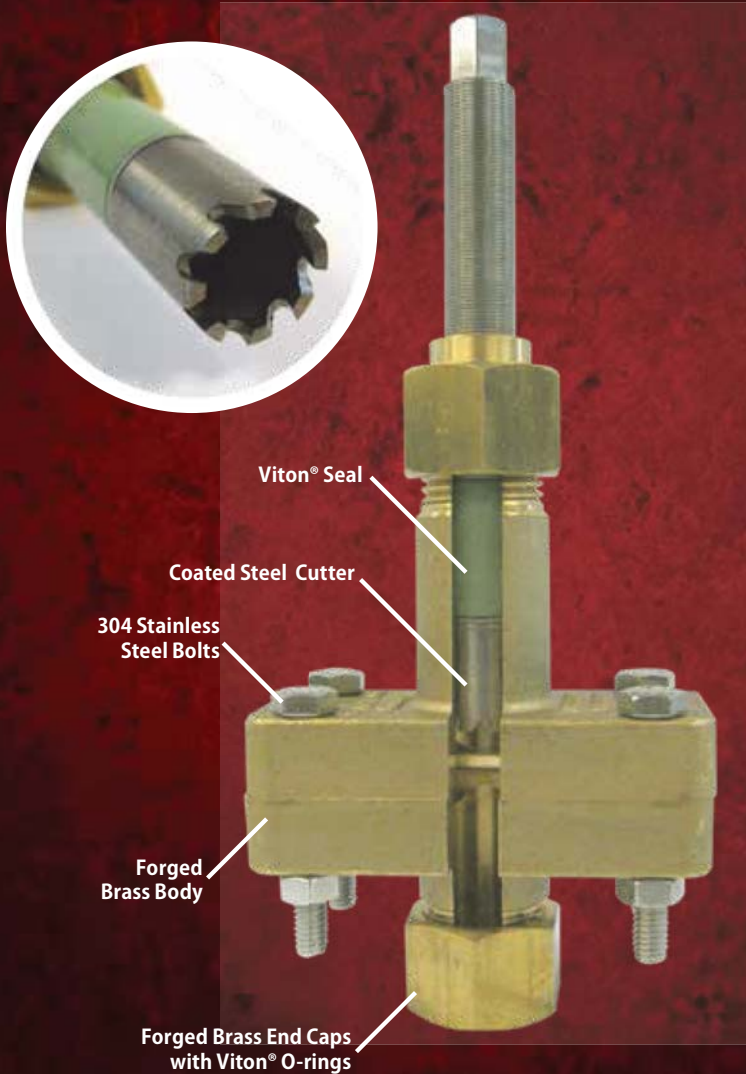

The Add-A-Valve® works by literally cutting through copper tubing with a hardened steel stem cutter and expanding a Viton® seal across the cut to stop the flow.

No Pipe Freezing!
No Bulky Nitrogen Tanks!
No Shut Downs!

The Add-A-Valve® can be installed on hot (220° F/104° C) or cold water, Glycol Systems, under pressure, from 0 to 250 PSI/17 bar max., on type M, L & K, copper tube. Available in sizes 1/2" - 2".

This is a basic step-by-step installation for sizes 1/2" - 1".

Jomar requires the installer to watch the video and read the instructions for proper installation.



Clean Pipe

Apply Sealant

Merge Halves

Test for Leaks

Ratchet
Stem Cutter

Stop Flow

*Times may vary depending on working conditions

Table of Contents



Lead Free

| | |
|--------------------------------|----|
| T-100NEG..... | 10 |
| JP-100GPxP..... | 10 |
| T-100C & S-100C..... | 10 |
| TWV-3W-KIT-G..... | 11 |
| TWV-3W-KIT-G-1..... | 11 |
| Pressure Relief Valves..... | 11 |
| JF-100TG & JF-100SG..... | 12 |
| JF-100TG-LH & JF-100SG-LH..... | 12 |
| T-110 & S-110..... | 13 |
| JF-100GMxF..... | 13 |
| T-83CG..... | 13 |
| T-100HFG & S-100HSG..... | 14 |
| JFPG-100..... | 14 |
| C-402G..... | 14 |
| T-412G & S-412G..... | 15 |
| Dielectric Union..... | 15 |
| Dielectric Union..... | 15 |
| T-511G & S-511G..... | 16 |
| T-501G & S-501G..... | 16 |
| T-301G & S-301G..... | 17 |
| T-302G..... | 17 |
| T-612G..... | 17 |
| T-601G & S-601G..... | 18 |
| T-611G & S-611G..... | 18 |
| T-621G & T-622G..... | 18 |
| T-641G & S-641G..... | 19 |
| T-653G..... | 19 |
| T-654G..... | 19 |

Brass Ball Valves

| | |
|--------------------------------|----|
| T-100NE & S-100NE..... | 20 |
| T-100SSE & S-100SSE..... | 20 |
| JP-100PxP & JP-100PxP XLC..... | 21 |
| T-100FMN & S-100FMN..... | 21 |
| T-100STN..... | 22 |
| S-100STN..... | 22 |
| T-100SSS..... | 22 |
| T-82M..... | 23 |
| T-100UE..... | 23 |
| S-100-DUE..... | 23 |
| T-100FB..... | 24 |
| T-100P-SS-WS..... | 24 |
| T-600-4B & S-600-4B..... | 24 |
| JF-100T & JF-100S..... | 25 |
| JF-100T-LH & JF-100S-LH..... | 25 |
| JF-100TFM..... | 26 |
| T-83C..... | 26 |
| JF-100T-FL..... | 27 |
| JF-100S-FL..... | 27 |
| T-110 & S-110..... | 27 |
| C-402..... | 28 |
| JFP-100..... | 28 |
| T-412 & S-412..... | 28 |
| JF-800 Series..... | 29 |
| TWV-3W-KIT..... | 29 |
| Pressure Relief Valve..... | 29 |

Medical Gas Ball Valves

| | |
|-------------------|----|
| S-650-CE-4B..... | 30 |
| S-675-GP-4B..... | 30 |
| S-675-DGP-4B..... | 30 |

Add-A-Valve®

| | |
|-------------------|----|
| Add-A-Valve®..... | 31 |
|-------------------|----|

Gas Ball Valves

| | |
|--------------|----|
| T-204DU..... | 31 |
| T-204..... | 32 |
| T-203DU..... | 33 |
| T-203..... | 33 |
| T-205..... | 34 |
| T-2005C..... | 34 |
| T-2004C..... | 34 |

Lockwings

| | |
|----------------------------------|----|
| 175-LWN..... | 35 |
| 125-LWN..... | 35 |
| 175-LWIN..... | 36 |
| 125-LWBP..... | 36 |
| 175-LWBP..... | 37 |
| 175-LWIBP..... | 37 |
| 125-LWUBP..... | 37 |
| 175-LWIBP Commercial Bypass..... | 38 |
| 175-LWBP Commercial Bypass..... | 38 |
| Bypass Key..... | 38 |

Thread Sealant

| | |
|-----------------------------|----|
| Gimme the White Stuff™..... | 39 |
| Gimme the Green Stuff™..... | 39 |
| The Heavyweight®..... | 40 |
| WOG Plus..... | 40 |
| Hi-Temp™..... | 41 |

Y-Strainer

| | |
|-----------------|----|
| Y-Strainer..... | 41 |
|-----------------|----|

Butterfly Valves

| | |
|--------------------|----|
| BFV-Lug..... | 42 |
| Lever Handle..... | 42 |
| BFV-Wafer..... | 43 |
| Gear Operator..... | 43 |

Carbon & Stainless Steel Ball Valves

| | |
|-----------------------|----|
| T-SS-1001N..... | 44 |
| T-CS-1001N-SS..... | 44 |
| T-SS-1001N-VB..... | 44 |
| T-SS-2000N..... | 45 |
| T-CS-2000N-SS..... | 45 |
| T-CS-2000N-SS-VB..... | 45 |
| T-SS-2000N-DH..... | 46 |
| T-SS-1000N-4B-VB..... | 46 |
| T-CS-4000..... | 47 |
| T-SS-2001N-SS-4B..... | 48 |
| T-CS-2001N-SS-4B..... | 48 |
| T-SS-1000..... | 49 |

Flanged Ball Valves

| | |
|--------------------|----|
| FL-SS-100-150..... | 50 |
| FL-SS-100-300..... | 50 |
| FL-CS-100-150..... | 51 |
| FL-CS-100-300..... | 51 |

Actuation

| | |
|-----------------------------|----|
| AE Series Actuators..... | 52 |
| Alpha Series Actuators..... | 53 |
| O-ring Repair Kits..... | 53 |
| Adapters..... | 53 |
| EP-100..... | 54 |
| PP-200..... | 54 |
| SV-120..... | 55 |
| SM-200..... | 55 |
| A2020D..... | 56 |
| A9000TD..... | 56 |
| A1000..... | 57 |
| A-750T & A-750L..... | 57 |
| A9500..... | 57 |
| A-850TL..... | 58 |
| A-766L..... | 58 |
| Mounting Brackets..... | 58 |

Low Pressure Valves

| | |
|-------------------------|----|
| T-511 & S-511..... | 59 |
| T-501 & S-501..... | 59 |
| T-301 & S-301..... | 59 |
| T-302..... | 60 |
| T-612..... | 60 |
| T-601 & S-601..... | 60 |
| T-611 & S-611..... | 61 |
| T-621 & T-622..... | 61 |
| T-641 & S-641..... | 61 |
| T-653 & T-654..... | 62 |
| T-540..... | 62 |
| T-632 & T-632 (NK)..... | 62 |

Thermoplastics/CPVC & PVC Valves

| | |
|--------------------|----|
| S-605..... | 63 |
| T-701 & S-701..... | 63 |
| T/S-703..... | 64 |
| T-711 & S-711..... | 64 |
| S-700..... | 64 |

Dielectric Unions

| | |
|-------------------------|----|
| Brass..... | 65 |
| Black Iron..... | 65 |
| Galvanized..... | 66 |
| Galvanized x Brass..... | 66 |
| Repair Kits..... | 66 |

Basket Strainers

| | |
|----------------------------|----|
| Snap-N-Loc®..... | 67 |
| Twist-N-Loc®..... | 67 |
| Easy-Loc®..... | 67 |
| Smart Move®..... | 67 |
| Mag-Na-Loc®..... | 67 |
| Snap-Tite®..... | 68 |
| Snap-N-Seal®..... | 68 |
| Push-N-Seal II®..... | 68 |
| Small Wonder®..... | 68 |
| Bar-ette®..... | 68 |
| Snap Loc..... | 69 |
| Disposer with Stopper..... | 69 |
| Twist Loc..... | 69 |

| | |
|--------------------------|----|
| Easy Loc..... | 69 |
| Basic Sink Strainer..... | 69 |
| Bar Sink Strainer..... | 69 |

Accessories

| | |
|---|----|
| Lift-N-Lock..... | 70 |
| Stem Extension..... | 70 |
| Long Neck T-handle..... | 70 |
| Slo-Ball Handle..... | 70 |
| Stem Memory Stop..... | 71 |
| Stainless Steel Lever Handle and Nut..... | 71 |
| Yellow Lever Handle..... | 71 |
| Round 304 Stainless Steel Handle..... | 71 |
| Red Aluminum T-handle..... | 72 |
| Red Aluminum Lever Handle..... | 72 |
| Square Head Top..... | 72 |
| Mufflers and Locks for Pneumatic Valves..... | 72 |
| Pressure Temperature Port..... | 72 |
| Locking Handle for T-SS-1001VB..... | 73 |
| Locking Handle for T-SS-2002N-DUE..... | 73 |
| Fits an T-SS-2002N-DUE..... | 73 |
| Round Handle for Low Pressure Valves..... | 73 |
| Cross Handle for T-301..... | 73 |
| Accessory Parts for T-302..... | 73 |
| Jo-Flo Stem Extension..... | 74 |
| Jo-Flo Locking Handle..... | 74 |
| Jo-Flo Stainless Steel Handle and Nut..... | 74 |
| Jo-Flo Lever Handles..... | 74 |
| Jo-Flo Red Aluminum T-handle..... | 74 |
| Flexible Hose Connectors..... | 75 |
| Filterball Replacement Filters..... | 75 |

Services

| | |
|----------------------------------|----|
| Oxygen Cleaning..... | 76 |
| Private Label..... | 76 |
| E-Commerce..... | 77 |
| Electronic Data Interchange..... | 77 |



Jomar Valve offers a **Lifetime Limited Warranty** for leakage through the valve stem for the valve models listed below. Because **Jomar** valves are equipped with a triple stem seal (double Viton® O-rings and Hostaflo® packing gland), valves properly installed and maintained within our normal recommendations for application and service are covered by warranty for life for leakage through the stem. The warranty will be nullified if it is determined that the product has been misused, abused, improperly installed or has failed as a result of freezing.

Jomar Valve models covered under this warranty are listed below. If a leak through the valve stem is detected, the packing nut should be tightened (if available). If after tightening the packing gland there is still stem leakage **Jomar Customer Service** should be contacted for a Return Goods Authorization (RGA) at 800-325-5690. Only once authorization has been obtained should the product be forwarded to Jomar at the address specified on the RGA via prepaid freight with the RGA number prominently displayed. For breach of this warranty on the products below the purchaser is limited to the following damages: If after factory analysis it is determined that a defect is present, **Jomar Valve** will forward a replacement product, freight paid, to the address listed on the RGA form unless instructed otherwise. If an exact replacement product is no longer available, Jomar Valve may opt to either replace the product with a similar product of type and/or function or refund the original purchase price of the returned product. Additionally a check in the amount of \$25.00 may be authorized to the installing contractor directly to offset any installation costs. This warranty specifically excludes incidental and consequential damages of any type resulting from a claimed defect in material or workmanship. This includes but is not limited to property damages and personal injury.

Models Covered Under Life Time Limited Warranty

| | | | |
|---------------|-------------|--------------|---------------|
| T-100NEG | S-100SSE | T-100FB | T-203DU |
| JP-100GPxP | T-100SSS | TWV-3W-KIT | 125-LWN (MxF) |
| T-100C | JP-100PxP | T-82 | 175-LWN |
| S-100C | JP-100P XLC | S-100-DUE | 175-LWIN |
| TWV-3W-KIT-G | T-100FMN | T-100P-SS-WS | 175-LWIBP |
| TWV-3W-KIT-G1 | S-100FMN | T-205 | 125-LWBP |
| T-100NE | T-100UE | T-204 | 175-LWBP |
| S-100NE | T-100STN | T-204DU | 125-LWUBP |
| T-100-SSE | S-100STN | T-203 | |

Note: Information is subject to change without notice.

Lead Free

T-100NEG

2 Piece • Full Port • Threaded Connection • 600 WOG

- Dezincification resistant lead free brass alloy
- NSF 61 Annex G / NSF 372 Certified
- 2 Viton® o-rings with Teflon® packing and packing nut
- Blow-out proof stem
- 100% leak tested
- Made in Italy
- Leakproof stem - Lifetime Warranty

Approvals

| Part # | Size | List price | Case | Carton | Weight |
|-------------|--------|------------|------|--------|--------|
| 100-703NGDZ | 1/2" | \$16.61 | 100 | 10 | - |
| 100-704NGDZ | 3/4" | \$23.44 | 72 | 6 | - |
| 100-705NGDZ | 1" | \$36.28 | 36 | 6 | - |
| 100-706NGDZ | 1-1/4" | \$66.20 | 24 | 6 | - |
| 100-707NGDZ | 1-1/2" | \$83.09 | 16 | 8 | - |
| 100-708NGDZ | 2" | \$117.09 | 12 | 6 | - |



T-100NEG

NEW

JP-100GPxP

2 Piece • Full Port • Press Connection • 250 WOG

- Dezincification resistant lead free brass alloy
- NSF 61 Annex G / NSF 372 Certified
- 2 Viton® o-rings with Teflon® packing and packing nut
- Blow-out proof stem
- 100% leak tested
- Made in Italy
- Leakproof stem - Lifetime Warranty

Approvals

| Part # | Size | List price | Case | Carton | Weight |
|----------|--------|------------|------|--------|--------|
| 100-203G | 1/2" | \$27.24 | 60 | 10 | 38 |
| 100-204G | 3/4" | \$32.68 | 40 | 10 | 42 |
| 100-205G | 1" | \$43.92 | 32 | 8 | 52 |
| 100-206G | 1-1/4" | \$75.41 | 24 | 4 | 50 |
| 100-207G | 1-1/2" | \$105.13 | 4 | 1 | 15 |
| 100-208G | 2" | \$180.03 | 4 | 1 | 21 |



JP-100GPXP

T-100C & S-100C

2 Piece • Full Port • 600 WOG

- Lead free brass alloy
- NSF 61 Annex G / NSF 372 Certified
- 2 Viton® o-rings with Teflon® packing and packing nut
- Blow-out proof stem
- 100% leak tested
- Made in Italy
- Leakproof stem - Lifetime Warranty

Approvals

| Threaded | Solder | Size | List price | Case | Carton | Qty |
|----------|----------|--------|------------|------|--------|-----|
| 100-403G | 100-413G | 1/2" | \$10.78 | 120 | 12 | 64 |
| 100-404G | 100-414G | 3/4" | \$16.20 | 72 | 12 | 64 |
| 100-405G | 100-415G | 1" | \$24.09 | 36 | 6 | 57 |
| 100-406G | 100-416G | 1-1/4" | \$39.95 | 24 | 4 | 60 |
| 100-407G | 100-417G | 1-1/2" | \$54.99 | 16 | 2 | 52 |
| 100-408G | 100-418G | 2" | \$95.11 | 12 | 2 | 61 |



T-100C



S-100C

Lead Free

TWV-3W-KIT-G

3 Way Ball • Tankless Water Heater Valve Kit • Standard Port • 600 WOG

- NSF 61 Annex G / NSF 372 Certified
- Color coded hot and cold lever handles
- Unique, T.E.A. Ternary Eco Alloy® Coated 3-way style ball
- 2 Viton® o-rings with Teflon® packing and packing nut
- U.S.A. Patent No. 7,762,280 B2
- 3/4" 200,000 BTU/hr LEAD FREE brass pressure relief valve included
- Lead free brass alloy
- 100% leak tested
- Made in Italy
- Leakproof stem - Lifetime Warranty



TWV-3W-KIT-G

Approvals

| Connection | Part # | Size | List price | Case | Carton | Weight |
|------------|----------|------|------------|------|--------|--------|
| Threaded | 810-504G | 3/4" | \$126.13 | 12 | 1 | 48 |
| Sweat | 810-514G | 3/4" | \$126.13 | 12 | 1 | 48 |

TWV-3W-KIT-G-1

3 Way Ball • Tankless Water Heater Valve Kit • Standard Port • 600 WOG

- NSF 61 Annex G / NSF 372 Certified
- Color coded hot and cold lever handles
- Unique, T.E.A. Ternary Eco Alloy® coated 3-way style ball
- 2 Viton® o-rings with Teflon® packing and packing nut
- U.S.A. Patent No. 7,762,280 B2
- Lead free brass alloy
- 100% leak tested
- Made in Italy
- Leakproof stem - Lifetime Warranty
- Relief valve sold separately



TWV-3W-KIT-G-1

Approvals

| Connection | Part # | Size | List price | Case | Carton | Weight |
|------------|----------|------|------------|------|--------|--------|
| Threaded | 810-505G | 1" | \$190.22 | 12 | 1 | 48 |

Pressure Relief Valves

- Forged brass construction
- Lead free brass alloy
- PRV - NSF 61 Annex G / NSF 372 Certified
- PRV - Carbon steel pressure spring
- PRV - Made in Italy
- CPRV - Stainless steel pressure spring

Approvals

| Item | Part # | Size | List price | Case | Carton | Weight |
|----------------------------------|----------|------|------------|------|--------|--------|
| Pressure Relief Valve | 203-104G | 3/4" | \$19.70 | 100 | 1 | 48.6 |
| Commercial Pressure Relief Valve | 203-304G | 3/4" | \$79.38 | 100 | 1 | 48.6 |



PRV



CPRV

JF-100TG & JF-100SG

2 Piece • Full Port • 600 WOG • with Stainless Steel Trim

- IAPMO Certified - NSF-61 Annex G
- 1 Buna-N o-ring with Teflon® packing and packing nut
- Blow-out proof stem
- Lead free brass alloy
- 100% leak tested

Approvals

| Threaded | Size | List price | Case | Carton | Weight |
|------------|--------|------------|------|--------|--------|
| 100-101SSG | 1/4" | \$5.97 | 120 | 10 | 40 |
| 100-102SSG | 3/8" | \$5.97 | 120 | 10 | 40 |
| 100-103SSG | 1/2" | \$7.99 | 100 | 10 | 50 |
| 100-104SSG | 3/4" | \$12.52 | 80 | 10 | 67 |
| 100-105SSG | 1" | \$19.63 | 48 | 8 | 58 |
| 100-106SSG | 1-1/4" | \$32.38 | 36 | 4 | 68 |
| 100-107SSG | 1-1/2" | \$43.93 | 24 | 2 | 61 |
| 100-108SSG | 2" | \$67.16 | 12 | 3 | 44 |
| 100-109SSG | 2-1/2" | \$158.60 | 6 | 1 | 49 |
| 100-110SSG | 3" | \$239.40 | 6 | 1 | 69 |
| 100-111SSG | 4" | \$408.05 | 2 | 1 | 40 |

| Solder | Size | List price | Case | Carton | Weight |
|------------|--------|------------|------|--------|--------|
| 100-113SSG | 1/2" | \$7.48 | 100 | 10 | 45 |
| 100-114SSG | 3/4" | \$11.91 | 80 | 10 | 67 |
| 100-115SSG | 1" | \$18.31 | 48 | 8 | 53 |
| 100-116SSG | 1-1/4" | \$32.38 | 36 | 4 | 68 |
| 100-117SSG | 1-1/2" | \$43.93 | 24 | 2 | 62 |
| 100-118SSG | 2" | \$67.16 | 12 | 3 | 47 |
| 100-119SSG | 2-1/2" | \$158.60 | 6 | 1 | 44 |
| 100-120SSG | 3" | \$239.40 | 6 | 1 | 55 |
| 100-121SSG | 4" | \$408.05 | 2 | 1 | 35 |

JFLO
by Jomar.



JF-100TG



JF-100SG

JF-100TG-LH & JF-100SG-LH

2 Piece • Full Port • 600 WOG • with Latch Lock Handle • with Stainless Steel Trim

- IAPMO Certified - NSF-61 Annex G
- 1 Buna-N o-ring with Teflon® packing and packing nut
- Blow-out proof stem
- Lead free brass alloy
- 100% leak tested

Approvals

| Threaded | Size | List price | Case | Carton | Weight |
|---------------|--------|------------|------|--------|--------|
| 100-101SSG-LH | 1/4" | \$6.72 | 120 | 10 | 40 |
| 100-102SSG-LH | 3/8" | \$6.72 | 120 | 10 | 40 |
| 100-103SSG-LH | 1/2" | \$8.74 | 100 | 10 | 50 |
| 100-104SSG-LH | 3/4" | \$13.27 | 80 | 10 | 67 |
| 100-105SSG-LH | 1" | \$20.63 | 48 | 8 | 58 |
| 100-106SSG-LH | 1-1/4" | \$33.38 | 36 | 4 | 68 |
| 100-107SSG-LH | 1-1/2" | \$44.93 | 24 | 2 | 61 |
| 100-108SSG-LH | 2" | \$68.66 | 12 | 3 | 44 |
| 100-109SSG-LH | 2-1/2" | \$160.10 | 6 | 1 | 49 |
| 100-110SSG-LH | 3" | \$240.90 | 6 | 1 | 69 |

| Solder | Size | List price | Case | Carton | Weight |
|---------------|--------|------------|------|--------|--------|
| 100-113SSG-LH | 1/2" | \$8.23 | 100 | 10 | 45 |
| 100-114SSG-LH | 3/4" | \$12.66 | 80 | 10 | 67 |
| 100-115SSG-LH | 1" | \$19.31 | 48 | 8 | 53 |
| 100-116SSG-LH | 1-1/4" | \$33.38 | 36 | 4 | 68 |
| 100-117SSG-LH | 1-1/2" | \$44.93 | 24 | 2 | 62 |
| 100-118SSG-LH | 2" | \$68.66 | 12 | 3 | 47 |
| 100-119SSG-LH | 2-1/2" | \$160.10 | 6 | 1 | 44 |
| 100-120SSG-LH | 3" | \$240.90 | 6 | 1 | 55 |

JFLO
by Jomar.



JF-100TG-LH



JF-100SG-LH

Lead Free

T-110 & S-110

2 Piece • Full Port • 600 WOG • with Drain • with Stainless Steel Trim

- Blow-out proof stem
- 1 Buna-N o-ring with Teflon® packing and packing nut
- Lead free brass alloy
- 100% leak tested
- Wetted surfaces contain less than .25% Lead content

| Threaded | Size | List price | Case | Carton | Weight |
|----------|------|------------|------|--------|--------|
| 100-633G | 1/2" | \$9.23 | 120 | 10 | 51 |
| 100-634G | 3/4" | \$13.87 | 80 | 10 | 47 |
| 100-635G | 1" | \$21.43 | 36 | 6 | 43 |

| Solder | Size | List price | Case | Carton | Weight |
|----------|------|------------|------|--------|--------|
| 100-643G | 1/2" | \$9.23 | 120 | 10 | 51 |
| 100-644G | 3/4" | \$13.87 | 80 | 10 | 47 |
| 100-645G | 1" | \$21.43 | 36 | 6 | 43 |



T-110G

S-110G

JF-100GMxF

2 Piece • Full Port • Male x Female Connections • 600 WOG • with Stainless Steel Trim

- IAPMO Certified - NSF-61 Annex G
- 1 Buna-N o-ring with Teflon® packing and packing nut
- Blow-out proof stem
- Lead free brass alloy
- 100% leak tested

Approvals

| Part # | Size | List price | Case | Carton | Weight |
|----------|------|------------|------|--------|--------|
| 100-131G | 1/4" | \$7.16 | 120 | 10 | 60 |
| 100-132G | 3/8" | \$7.25 | 120 | 10 | 60 |
| 100-133G | 1/2" | \$10.24 | 100 | 10 | 50 |
| 100-134G | 3/4" | \$15.42 | 80 | 10 | 60 |
| 100-135G | 1" | \$22.39 | 48 | 8 | 58 |



JF-100GMXF

T-83CG

2 Piece • Full Port • 600 WOG • with Stainless Steel Trim

- Large raised wrench flats
- 100% leak tested
- Lead free brass alloy
- Wetted surfaces contain less than .25% Lead content

| 1/4 Turn Handle | Size | List price | Case | Carton | Weight |
|-----------------|---------------------|------------|------|--------|--------|
| 100-397G | 1/8" FIP x 1/8" MIP | \$5.27 | 250 | 25 | 70 |
| 100-398G | 1/4" FIP x 1/8" MIP | \$5.27 | 200 | 20 | 70 |
| 100-399G | 1/4" FIP x 1/4" MIP | \$5.27 | 250 | 25 | 40 |
| 100-400G | 1/4" FIP x 1/4" FIP | \$5.27 | 200 | 20 | 49 |

| T-handle | Size | List price | Case | Carton | Weight |
|------------|---------------------|------------|------|--------|--------|
| 100-397THG | 1/8" FIP x 1/8" MIP | \$5.37 | 250 | 25 | 70 |
| 100-398THG | 1/4" FIP x 1/8" MIP | \$5.37 | 200 | 20 | 70 |
| 100-399THG | 1/4" FIP x 1/4" MIP | \$5.37 | 250 | 25 | 40 |
| 100-400THG | 1/4" FIP x 1/4" FIP | \$5.37 | 200 | 20 | 49 |



100-397G

100-398G

100-399G

100-400G



100-397THG

100-398THG

100-399THG

100-400THG

T-83CG

Lead Free

T-100HFG & S-100HSG

2 Piece • Full Port • Hose Connection • 600 WOG • with Cap and Chain
• with Stainless Steel Trim

- Meets EPA Guidelines for safe drinking water
- 1 Buna-N o-ring with Teflon® packing and packing nut
- Heavy steel chain
- Blow-out proof stem
- 100% leak tested
- Lead free brass alloy
- Wetted surfaces contain less than .25% Lead content

| Threaded | Size | List price | Case | Carton | Weight |
|----------|------|------------|------|--------|--------|
| 100-653G | 1/2" | \$13.22 | 100 | 10 | 46 |
| 100-654G | 3/4" | \$17.86 | 60 | 10 | 75 |
| 100-655G | 1" | \$23.50 | 36 | 6 | 51 |

| Sweat | Size | List price | Case | Carton | Weight |
|----------|------------------|------------|------|--------|--------|
| 100-663G | 1/2" x 3/4" Hose | \$12.69 | 100 | 10 | 46 |
| 100-664G | 3/4" x 3/4" Hose | \$17.18 | 60 | 10 | 75 |



JFPG-100

2 Piece • Full Port • Push-Fit Connection • 200 WOG

- Easy to connect and fit in seconds
- Connects with copper, CPVC and PEX
- Teflon® packing and packing nut
- Includes two pipe reinforcers and release tool
- 100% leak tested
- Lead free brass alloy
- Wetted surfaces contain less than .25% Lead content

Approvals

| Part # | Size | List price | Case | Carton | Weight |
|-------------|------|------------|------|--------|--------|
| 100-103JFPG | 1/2" | \$18.42 | 100 | 10 | 39 |
| 100-104JFPG | 3/4" | \$27.90 | 100 | 10 | 60 |
| 100-105JFPG | 1" | \$49.08 | 50 | 5 | 49 |



C-402G

2 Piece • Full Port • Compression Connection • 600 WOG • with Drain • with Stainless Steel Trim

- Drain feature prevents freeze-up
- Eliminates seat damage during soldering
- Compression ends ease maintenance
- Blow-out proof stem
- 1 Buna-N o-ring with Teflon® packing and packing nut
- 100% leak tested
- Lead free brass alloy
- Wetted surfaces contain less than .25% Lead content

| Part # | Size | List price | Case | Carton | Weight |
|----------|------|------------|------|--------|--------|
| 102-653G | 1/2" | \$11.73 | 120 | 10 | 60 |
| 102-654G | 3/4" | \$16.87 | 90 | 10 | 61 |
| 102-655G | 1" | \$25.27 | 60 | 6 | 71 |



Lead Free

T-412G & S-412G

2 Piece • Standard Port • Pex Connection • 600 WOG • with Stainless Steel Trim

- IAPMO Certified - NSF-61 Annex G
- 1 Buna-N o-ring with Teflon® packing and packing nut
- Blow-out proof stem
- Lead free brass alloy
- 100% leak tested

Approvals

| PEX x PEX | Size | List price | Case | Carton | Weight |
|-----------|------|------------|------|--------|--------|
| 103-523PG | 1/2" | \$6.07 | 120 | 10 | 33 |
| 103-524PG | 3/4" | \$8.08 | 120 | 10 | 50 |
| 103-525PG | 1" | \$13.27 | 54 | 6 | 37 |

| Solder x PEX | Size | List price | Case | Carton | Weight |
|--------------|------|------------|------|--------|--------|
| 103-533PG | 1/2" | \$8.68 | 120 | 10 | 33 |
| 103-534PG | 3/4" | \$12.67 | 120 | 10 | 50 |

| MIP x PEX | Size | List price | Case | Carton | Weight |
|------------|------|------------|------|--------|--------|
| 103-534MPG | 3/4" | \$9.84 | 120 | 10 | 50 |



T-412G

S-412G

Dielectric Union

Brass Solder x Galvanized • 250 PSI

- Prevents accelerated corrosion
- Lead free brass alloy
- Wetted surfaces contain less than .25% Lead content

| FIP x Solder | Size | List price | Case | Carton | Weight |
|--------------|--------|------------|------|--------|--------|
| 701-103G | 1/2" | \$4.45 | 144 | 12 | 48 |
| 701-104G | 3/4" | \$5.81 | 144 | 12 | 62 |
| 701-105G | 1" | \$8.32 | 72 | 12 | 41 |
| 701-106G | 1-1/4" | \$12.02 | 72 | 6 | 62 |
| 701-107G | 1-1/2" | \$17.66 | 36 | 6 | 49 |
| 701-108G | 2" | \$29.69 | 24 | 6 | 62 |

| FIP x Reducing Solder | Size | List price | Case | Carton | Weight |
|-----------------------|-------------|------------|------|--------|--------|
| 701-204G | 1/2" x 3/4" | \$5.74 | 144 | 12 | 62 |

| MIP x Solder | Size | List price | Case | Carton | Weight |
|--------------|-------------|------------|------|--------|--------|
| 701-303G | 1/2" | \$6.49 | 96 | 12 | 48 |
| 701-304G | 3/4" | \$7.95 | 96 | 12 | 56 |
| 701-305G | 1/2" x 3/4" | \$7.71 | 96 | 12 | 56 |
| 701-306G | 1" | \$11.14 | 72 | 12 | 59 |

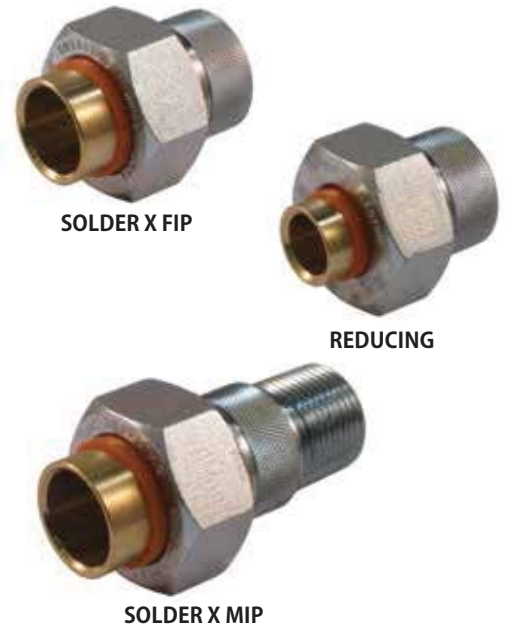

SOLDER X FIP

REDUCING

SOLDER X MIP

Dielectric Union

Brass FIP x Galvanized FIP • 250 PSI

- Prevents accelerated corrosion
- Lead free brass alloy
- Wetted surfaces contain less than .25% Lead content

| Part # | Size | List price | Case | Carton | Weight |
|----------|------|------------|------|--------|--------|
| 701-503G | 1/2" | \$6.96 | 100 | 10 | 51 |
| 701-504G | 3/4" | \$9.78 | 100 | 10 | 68 |
| 701-505G | 1" | \$14.88 | 50 | 5 | 53 |



FIP X FIP

Lead Free

T-511G & S-511G

300 WOG

- Vertical or horizontal positions
- Lead free brass alloy
- Wetted surfaces contain less than .25% Lead content

| Threaded | Size | List price | Case | Carton | Weight |
|----------|--------|------------|------|--------|--------|
| 105-303G | 1/2" | \$41.39 | 60 | 10 | 40 |
| 105-304G | 3/4" | \$56.29 | 40 | 10 | 36 |
| 105-305G | 1" | \$88.02 | 30 | 10 | 45 |
| 105-306G | 1-1/4" | \$116.48 | 20 | 5 | 45 |
| 105-307G | 1-1/2" | \$174.16 | 16 | 4 | 50 |
| 105-308G | 2" | \$237.30 | 8 | 2 | 40 |

| Solder | Size | List price | Case | Carton | Weight |
|----------|--------|------------|------|--------|--------|
| 105-403G | 1/2" | \$41.39 | 60 | 10 | 36 |
| 105-404G | 3/4" | \$56.29 | 40 | 10 | 36 |
| 105-405G | 1" | \$88.02 | 30 | 10 | 44 |
| 105-406G | 1-1/4" | \$116.48 | 20 | 5 | 44 |
| 105-407G | 1-1/2" | \$174.16 | 16 | 4 | 49 |
| 105-408G | 2" | \$236.61 | 8 | 2 | 39 |



T-511G



S-511G

T-501G & S-501G

200 WOG

- Residential and commercial applications
- Lead free brass alloy
- Wetted surfaces contain less than .25% Lead content

| Threaded | Solder | Size | List price | Case | Carton | Weight |
|----------|----------|--------|------------|------|--------|--------|
| 105-103G | 105-203G | 1/2" | \$10.50 | 160 | 10 | 76 |
| 105-104G | 105-204G | 3/4" | \$13.66 | 120 | 10 | 78 |
| 105-105G | 105-205G | 1" | \$18.38 | 72 | 6 | 74 |
| 105-106G | 105-206G | 1-1/4" | \$30.95 | 60 | 5 | 89 |
| 105-107G | 105-207G | 1-1/2" | \$39.20 | 32 | 4 | 63 |
| 105-108G | 105-208G | 2" | \$62.09 | 24 | 2 | 70 |



T-501G



S-501G

Lead Free

T-301G & S-301G

Non-rising Stem • 200 WOG

- Manufactured in ISO-9001 facility
- ANSI B16.20.1 threaded ends
- Solid wedge gate
- Lead free brass alloy
- Wetted surfaces contain less than .25% Lead content

| Threaded | Solder | Size | List price | Case | Carton | Weight |
|----------|----------|--------|------------|------|--------|--------|
| 103-301G | – | 1/4" | \$11.03 | 120 | 10 | 70 |
| 103-302G | – | 3/8" | \$11.03 | 120 | 10 | 68 |
| 103-303G | 103-403G | 1/2" | \$11.03 | 120 | 10 | 72 |
| 103-304G | 103-404G | 3/4" | \$14.96 | 90 | 10 | 77 |
| 103-305G | 103-405G | 1" | \$22.38 | 60 | 5 | 72 |
| 103-306G | 103-406G | 1-1/4" | \$31.61 | 40 | 5 | 74 |
| 103-307G | 103-407G | 1-1/2" | \$40.20 | 32 | 4 | 72 |
| 103-308G | 103-408G | 2" | \$60.55 | 20 | 2 | 68 |



T-301G

S-301G

T-302G

Non-rising Stem • Compression Connection • 200 WOG

- Manufactured in ISO-9001 facility
- Solid wedge gate
- Lead free brass alloy
- Wetted surfaces contain less than .25% Lead content

| Part # | Size | List price | Case | Carton | Weight |
|----------|------|------------|------|--------|--------|
| 103-423G | 1/2" | \$14.39 | 120 | 10 | 97 |
| 103-424G | 3/4" | \$19.56 | 90 | 10 | 92 |
| 103-425G | 1" | \$29.39 | 60 | 5 | 88 |



T-302G

T-612G

Compression Connection • 200 WOG

- Manufactured in ISO-9001 facility
- Lead free brass alloy
- Wetted surfaces contain less than .25% Lead content

| Part # | Size | List price | Case | Carton | Weight |
|----------|------|------------|------|--------|--------|
| 200-313G | 1/2" | \$12.59 | 100 | 10 | 55 |
| 200-314G | 3/4" | \$17.41 | 100 | 10 | 70 |



T-612G

Lead Free

T-601G & S-601G

200 WOG

- Manufactured in ISO-9001 facility
- Lead free brass alloy
- Wetted surfaces contain less than .25% Lead content

| Threaded | Size | List price | Case | Carton | Weight |
|----------|------|------------|------|--------|--------|
| 200-003G | 1/2" | \$9.38 | 100 | 10 | 59 |
| 200-004G | 3/4" | \$10.37 | 100 | 10 | 64 |

| Solder | Size | List price | Case | Carton | Weight |
|----------|------|------------|------|--------|--------|
| 200-103G | 1/2" | \$8.24 | 100 | 10 | 53 |
| 200-104G | 3/4" | \$9.64 | 100 | 10 | 60 |



T-601G



S-601G

T-611G & S-611G

200 WOG

- Manufactured in ISO-9001 facility
- Lead free brass alloy
- Wetted surfaces contain less than .25% Lead content

| Threaded | Size | List price | Case | Carton | Weight |
|----------|------|------------|------|--------|--------|
| 200-203G | 1/2" | \$9.80 | 100 | 10 | 60 |
| 200-204G | 3/4" | \$10.78 | 100 | 10 | 66 |

| Solder | Size | List price | Case | Carton | Weight |
|----------|------|------------|------|--------|--------|
| 200-303G | 1/2" | \$8.66 | 100 | 10 | 52 |
| 200-304G | 3/4" | \$10.02 | 100 | 10 | 62 |



T-611G



S-611G

T-621G & T-622G

125 WOG

- Manufactured in ISO-9001 facility
- Heavy pattern brass
- Lead free brass alloy
- Wetted surfaces contain less than .25% Lead content

| Part # | Size | List price | Case | Carton | Weight |
|----------|------|------------|------|--------|--------|
| 201-003G | 1/2" | \$8.88 | 100 | 10 | 53 |
| 201-004G | 3/4" | \$9.16 | 100 | 10 | 57 |

| Part # | Size | List price | Case | Carton | Weight |
|----------|------|------------|------|--------|--------|
| 201-103G | 1/2" | \$8.59 | 100 | 10 | 46 |
| 201-104G | 3/4" | \$9.29 | 100 | 10 | 51 |



T-621G



T-622G

Lead Free

T-641G & S-641G

125 WOG

- Manufactured in ISO-9001 facility
- 3/4" hose thread outlet
- Lead free brass alloy
- Wetted surfaces contain less than .25% Lead content

| Threaded | Size | List price | Case | Carton | Weight |
|----------|------|------------|------|--------|--------|
| 202-003G | 1/2" | \$9.04 | 100 | 10 | 58 |
| 202-004G | 3/4" | \$9.80 | 100 | 10 | 64 |

| Solder | Size | List price | Case | Carton | Weight |
|----------|------|------------|------|--------|--------|
| 202-103G | 1/2" | \$10.02 | 100 | 10 | 59 |
| 202-104G | 3/4" | \$9.57 | 100 | 10 | 65 |



T-641G

S-641G

T-653G

Lead Free Vacuum Breaker

- 3/4" hose connection
- Tamper-resistant breakaway screw
- Heavy brass construction
- POM internal components
- Lead free brass alloy
- Wetted surfaces contain less than .25% Lead content

| Part # | Size | List price | Case | Carton | Weight |
|----------|------|------------|------|--------|--------|
| 203-204G | 3/4" | \$7.86 | 240 | 20 | 51 |



T-653G

T-654G

Lead Free Chrome-Plated Vacuum Breaker

- 3/4" hose connection
- Tamper-resistant breakaway screw
- Heavy brass construction
- POM internal components
- Lead free brass alloy
- Wetted surfaces contain less than .25% Lead content

| Part # | Size | List price | Case | Carton | Weight |
|----------|------|------------|------|--------|--------|
| 203-205G | 3/4" | \$8.23 | 240 | 20 | 51 |



T-654G

Brass Ball Valves



T-100NE & S-100NE

2 Piece • Full Port • 600 WOG

- Blow-out proof stem
- 2 Viton® o-rings with Teflon® packing and packing nut
- 100% leak tested
- Made in Italy
- Leakproof stem - Lifetime Warranty

Approvals   

| Threaded | Solder | Size | List price | Case | Carton | Weight |
|----------|---------|--------|------------|------|--------|--------|
| 100-701 | - | 1/4" | \$11.82 | 120 | 12 | 42 |
| 100-702 | - | 3/8" | \$11.82 | 120 | 12 | 40 |
| 100-703 | 100-803 | 1/2" | \$11.82 | 120 | 12 | 64 |
| 100-704 | 100-804 | 3/4" | \$16.64 | 72 | 12 | 64 |
| 100-705 | 100-805 | 1" | \$27.07 | 36 | 6 | 57 |
| 100-706 | 100-806 | 1-1/4" | \$47.01 | 24 | 4 | 60 |
| 100-707 | 100-807 | 1-1/2" | \$59.04 | 16 | 2 | 52 |
| 100-708 | 100-808 | 2" | \$88.17 | 12 | 2 | 61 |
| 100-709 | 100-809 | 2-1/2" | \$204.78 | 6 | 2 | 48 |
| 100-710 | 100-810 | 3" | \$301.91 | 4 | 2 | 53 |
| 100-711 | - | 4" | \$525.75 | 2 | 1 | 53 |



T-100NE

S-100NE

T-100SSE & S-100SSE

2 Piece • Full Port • 600 WOG • with Stainless Steel Trim

- Blow-out proof stem
- T.E.A. Ternary Eco Alloy® coated body
- 2 Viton® o-rings with Teflon® packing and packing nut
- 100% leak tested
- Made in Italy
- Leakproof stem - Lifetime Warranty

Approvals  

| Threaded | Solder | Size | List price | Case | Carton | Weight |
|----------|---------|--------|------------|------|--------|--------|
| 100-501 | - | 1/4" | \$24.10 | 120 | 12 | 41 |
| 100-502 | - | 3/8" | \$24.10 | 120 | 12 | 40 |
| 100-503 | 100-513 | 1/2" | \$24.10 | 120 | 12 | 64 |
| 100-504 | 100-514 | 3/4" | \$32.25 | 72 | 12 | 65 |
| 100-505 | 100-515 | 1" | \$47.36 | 36 | 6 | 51 |
| 100-506 | 100-516 | 1-1/4" | \$70.88 | 24 | 4 | 50 |
| 100-507 | 100-517 | 1-1/2" | \$94.69 | 16 | 4 | 55 |
| 100-508 | 100-518 | 2" | \$131.04 | 12 | 2 | 68 |
| 100-509 | 100-519 | 2-1/2" | \$357.64 | 6 | 2 | 67 |
| 100-510 | 100-520 | 3" | \$515.68 | 4 | 2 | 69 |



T-100SSE

S-100SSE

Brass Ball Valves

JP-100PxP & JP-100PxP XLC

2 Piece • Full Port • Press Connections • 250 WOG • 200 WOG XLC

- 2 Viton® o-rings with Teflon® packing and packing nut
- Blow-out proof stem
- Corrosion resistant brass
- 100% leak tested
- Made in Italy
- Leakproof stem - Lifetime Warranty

Approvals

| Part # | Size | List price | Case | Carton | Weight |
|------------|--------|------------|------|--------|--------|
| 100-203 | 1/2" | \$20.10 | 60 | 10 | 38 |
| 100-204 | 3/4" | \$24.10 | 40 | 10 | 42 |
| 100-205 | 1" | \$32.41 | 32 | 8 | 52 |
| 100-206 | 1-1/4" | \$55.63 | 24 | 4 | 50 |
| 100-207 | 1-1/2" | \$77.55 | 4 | 1 | 15 |
| 100-208 | 2" | \$132.80 | 4 | 1 | 21 |
| 100-209XLC | 2-1/2" | \$238.81 | 6 | 1 | 54 |
| 100-210XLC | 3" | \$517.17 | 4 | 1 | 56 |
| 100-211XLC | 4" | \$706.52 | 1 | 1 | 27 |



JP-100XP

JP-100XP XLC

T-100FMN & S-100FMN

2 Piece • Full Port • 600 WOG

- Blow-out proof stem
- 2 Viton® o-rings with Teflon® packing and packing nut
- 100% leak tested
- Made in Italy
- Leakproof stem - Lifetime Warranty

Approvals

| Threaded | Size | List price | Case | Carton | Weight |
|----------|------|------------|------|--------|--------|
| 100-601 | 1/4" | \$13.01 | 100 | 10 | 42 |
| 100-602 | 3/8" | \$13.01 | 100 | 10 | 42 |
| 100-603 | 1/2" | \$13.01 | 100 | 10 | 42 |
| 100-604 | 3/4" | \$18.41 | 60 | 10 | 52 |
| 100-605 | 1" | \$28.47 | 36 | 6 | 51 |

| Solder | Size | List price | Case | Carton | Weight |
|---------|------|------------|------|--------|--------|
| 100-613 | 1/2" | \$17.87 | 100 | 10 | 42 |
| 100-614 | 3/4" | \$25.58 | 60 | 10 | 52 |
| 100-615 | 1" | \$36.28 | 36 | 6 | 51 |



T-100FMN

S-100FMN

Brass Ball Valves



T-100STN

2 Piece • Full Port • Threaded Connection • 600 WOG • with Side Tap

- Blow-out proof stem
- 2 Viton® o-rings with Teflon® packing and packing nut
- 3/8" - 1" have 1/8" FIP side tap
- 1-1/4" - 2" have 1/4" FIP side tap
- 100% leak tested
- Made in Italy
- Leakproof stem - Lifetime Warranty

Approvals  

| Part # | Size | List price | Case | Carton | Weight |
|---------|--------|------------|------|--------|--------|
| 170-102 | 3/8" | \$20.09 | 100 | 10 | 65 |
| 170-103 | 1/2" | \$23.39 | 100 | 10 | 65 |
| 170-104 | 3/4" | \$30.16 | 60 | 10 | 53 |
| 170-105 | 1" | \$48.14 | 36 | 6 | 62 |
| 170-106 | 1-1/4" | \$82.60 | 24 | 4 | 55 |
| 170-107 | 1-1/2" | \$111.43 | 16 | 2 | 57 |
| 170-108 | 2" | \$155.17 | 12 | 2 | 60 |



T-100STN

S-100STN

2 Piece • Full Port • Solder Connection • 600 WOG • with Side Tap

- Blow-out proof stem
- 2 Viton® o-rings with Teflon® packing and packing nut
- Ice maker valve
- 1/8" side tap
- 100% leak tested
- Made in Italy
- Leakproof stem - Lifetime Warranty

| Part # | Size | List price | Case | Carton | Weight |
|---------|------|------------|------|--------|--------|
| 100-823 | 1/2" | \$22.28 | 100 | 10 | 53 |
| 100-824 | 3/4" | \$29.93 | 60 | 10 | 57 |
| 100-825 | 1" | \$40.33 | 30 | 5 | 51 |



S-100STN

T-100SSS

2 Piece • Full Port • 600 WOG • with Steam Trim

- 2 Viton® o-rings with Teflon® packing and packing nut
- Blow-out proof stem
- 250 WSP rating
- Patent pending design
- Special high temperature resistant handle
- 100% leak tested
- Made in Italy
- Leakproof stem - Lifetime Warranty

| Part # | Size | List price | Case | Carton | Weight |
|---------|--------|------------|------|--------|--------|
| 100-533 | 1/2" | \$39.17 | 100 | 10 | - |
| 100-534 | 3/4" | \$63.59 | 72 | 6 | - |
| 100-535 | 1" | \$74.80 | 36 | 6 | - |
| 100-536 | 1-1/4" | \$103.37 | 24 | 6 | - |
| 100-537 | 1-1/2" | \$125.04 | 16 | 8 | - |
| 100-538 | 2" | \$208.16 | 12 | 6 | - |



T-100SSS

Brass Ball Valves



T-82M

2 Piece • Full Port • Mini Valves 600 WOG

- Greater flow rate
- Blow-out-proof stem
- Prevents stem leakage
- 2 Viton® o-rings
- Large raised wrench flats
- 100% leak tested
- Made in Italy
- Leakproof stem - Lifetime Warranty

Approvals

| Screw Driver Slot | Size | List price | Case | Carton | Weight |
|-------------------|---------------------|------------|------|--------|--------|
| 100-295 | 1/4" FIP x 1/4" MIP | \$8.85 | 350 | 35 | 70 |
| 100-296 | 1/4" FIP x 1/8" MIP | \$8.85 | 350 | 35 | 70 |

| Regular Handle | Size | List price | Case | Carton | Weight |
|----------------|---------------------|------------|------|--------|--------|
| 100-297 | 1/8" FIP x 1/8" MIP | \$12.42 | 200 | 20 | 40 |
| 100-298 | 1/4" FIP x 1/8" MIP | \$12.42 | 250 | 25 | 49 |
| 100-299 | 1/4" FIP x 1/4" MIP | \$8.85 | 200 | 20 | 49 |
| 100-300 | 1/4" FIP x 1/4" FIP | \$8.85 | 250 | 25 | 49 |



T-82M

T-100UE

2 Piece • Full Port • Single Union End • Threaded Connection 600 WOG • with Side Tap

- FIP x union FIP
- 3/8" - 1" have 1/8" FIP side tap
- 1-1/4" - 2" have 1/4" FIP side tap
- 2 Viton® o-rings with Teflon® packing and packing nut
- Blow-out proof stem
- 100% leak tested
- Made in Italy
- Leakproof stem - Lifetime Warranty

Approvals

| Part # | Size | List price | Case | Carton | Weight |
|---------|--------|------------|------|--------|--------|
| 160-102 | 3/8" | \$26.90 | - | - | - |
| 160-103 | 1/2" | \$34.59 | 60 | 10 | 54 |
| 160-104 | 3/4" | \$41.21 | 36 | 6 | 48 |
| 160-105 | 1" | \$64.10 | 24 | 4 | 56 |
| 160-106 | 1-1/4" | \$115.88 | 16 | 2 | 56 |
| 160-107 | 1-1/2" | \$154.37 | 8 | 2 | 58 |
| 160-108 | 2" | \$231.66 | 8 | 2 | 60 |



T-100UE

S-100-DUE

2 Piece • Full Port • Double Union End • Solder Connection 600 WOG

- Unions on inlet and outlet
- 2 Viton® o-rings with Teflon® packing and packing nut
- Blow-out proof stem
- Corrosion resistant brass
- 100% leak tested
- Made in Italy
- Leakproof stem - Lifetime Warranty

| Part # | Size | List price | Case | Carton | Weight |
|---------|--------|------------|------|--------|--------|
| 160-503 | 1/2" | \$30.91 | 48 | 12 | 36 |
| 160-504 | 3/4" | \$42.34 | 48 | 8 | 58 |
| 160-505 | 1" | \$59.48 | 24 | 4 | 52 |
| 160-506 | 1-1/4" | \$77.82 | 16 | 4 | 51 |
| 160-507 | 1-1/2" | \$115.66 | 16 | 2 | 74 |
| 160-508 | 2" | \$176.90 | 4 | 2 | 30 |



S-100-DUE

Brass Ball Valves



T-100FB

Full Port • Threaded Connection • 400 WOG • with Integrated Strainer

- Shipped standard with 304 SS 20 mesh screen
 - Available mesh screens: 40, 60, 80, 100
- 2 Viton® o-rings with Teflon® packing and packing nut
- Blow-out proof stem
- Corrosion resistant brass
- Locking device available
- 100% leak tested
- Made in Italy
- Leakproof stem - Lifetime Warranty

| Part # | Size | List price | Case | Carton | Weight |
|---------|--------|------------|------|--------|--------|
| 100-833 | 1/2" | \$40.83 | 16 | 4 | 30 |
| 100-834 | 3/4" | \$42.43 | 16 | 4 | 28 |
| 100-835 | 1" | \$69.57 | 12 | 3 | 33 |
| 100-836 | 1-1/4" | \$123.74 | 8 | 4 | 35 |
| 100-837 | 1-1/2" | \$159.56 | 4 | 2 | 26 |
| 100-838 | 2" | \$239.72 | 2 | 1 | 26 |



T-100FB

T-100P-SS-WS

2 Piece • Full Port • Threaded Connection • 600 WOG with Automatic Vent

- Quiet operation
- Raised boss to accept NPT threaded muffler
- Muffler available cone or flat
- Automatic downstream venting in closed position
- Reduces compressed air noise to OSHA levels
- 2 Viton® o-rings with Teflon® packing and packing nut
- 100% leak tested
- Made in Italy
- Leakproof stem - Lifetime Warranty

| Part # | Size | List price | Case | Carton | Weight |
|---------|------|------------|------|--------|--------|
| 100-923 | 1/2" | \$24.63 | 72 | 12 | 48 |
| 100-924 | 3/4" | \$24.63 | 48 | 8 | 50 |
| 100-925 | 1" | \$29.20 | 36 | 6 | 67 |



T-100P-SS-WS

T-600-4B & S-600-4B

3 Piece 4 Bolt • Full Port • 600 WOG • with Stainless Steel Trim

- Latch lock handle standard
- 2 Viton® o-rings with Teflon® packing and packing nut
- 3 piece swing out body
- 100% leak tested

| Threaded | Solder | Size | List price | Case | Carton | Weight |
|----------|---------|--------|------------|------|--------|--------|
| 500-603 | 500-613 | 1/2" | \$35.35 | 10 | 10 | 13 |
| 500-604 | 500-614 | 3/4" | \$52.34 | 10 | 10 | 16 |
| 500-605 | 500-615 | 1" | \$66.26 | 8 | 8 | 16 |
| 500-606 | 500-616 | 1-1/4" | \$106.86 | 5 | 5 | 17 |
| 500-607 | 500-617 | 1-1/2" | \$142.55 | 4 | 4 | 18 |
| 500-608 | 500-618 | 2" | \$250.98 | 2 | 2 | 15 |



T-600-4B

S-600-4B



Brass Ball Valves

JF-100T & JF-100S

2 Piece • Full Port • 600 WOG

- 1 Buna-N o-ring with Teflon® packing and packing nut
- Blow-out proof stem
- 100% leak tested

Approvals US FIRE PROTECTION JF-100T Only

| Part # | Size | List price | Case | Carton | Weight |
|---------|--------|------------|------|--------|--------|
| 100-101 | 1/4" | \$4.00 | 120 | 10 | 40 |
| 100-102 | 3/8" | \$4.00 | 120 | 10 | 40 |
| 100-103 | 1/2" | \$6.23 | 100 | 10 | 50 |
| 100-104 | 3/4" | \$10.03 | 80 | 10 | 67 |
| 100-105 | 1" | \$15.89 | 48 | 8 | 58 |
| 100-106 | 1-1/4" | \$26.29 | 36 | 4 | 68 |
| 100-107 | 1 1/2" | \$35.33 | 24 | 2 | 61 |
| 100-108 | 2" | \$54.10 | 12 | 3 | 44 |
| 100-109 | 2 1/2" | \$128.69 | 6 | 1 | 49 |
| 100-110 | 3" | \$192.71 | 6 | 1 | 69 |
| 100-111 | 4" | \$328.36 | 2 | 1 | 40 |

| Solder | Size | List price | Case | Carton | Weight |
|---------|--------|------------|------|--------|--------|
| 100-113 | 1/2" | \$5.59 | 100 | 10 | 45 |
| 100-114 | 3/4" | \$9.46 | 80 | 10 | 61 |
| 100-115 | 1" | \$14.71 | 48 | 8 | 53 |
| 100-116 | 1-1/4" | \$26.29 | 36 | 4 | 68 |
| 100-117 | 1 1/2" | \$35.33 | 24 | 2 | 62 |
| 100-118 | 2" | \$54.10 | 12 | 3 | 47 |
| 100-119 | 2 1/2" | \$128.69 | 6 | 1 | 44 |
| 100-120 | 3" | \$192.71 | 6 | 1 | 55 |
| 100-121 | 4" | \$328.36 | 2 | 1 | 35 |

JFLO
by Jomar

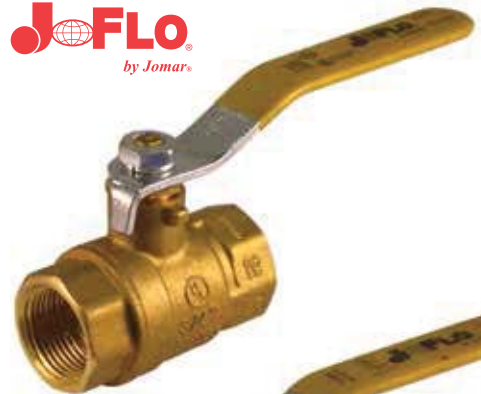

JF-100T



JF-100S

JF-100T-LH & JF-100S-LH

2 Piece • Full Port • 600 WOG • with Latch Lock Handle

- 1 Buna-N o-ring with Teflon® packing and packing nut
- Blow-out proof stem
- 100% leak tested

Approvals US FIRE PROTECTION JF-100T-LH Only

| Part # | Size | List price | Case | Carton | Weight |
|-----------|--------|------------|------|--------|--------|
| 100-101LH | 1/4" | \$4.80 | 120 | 10 | 40 |
| 100-102LH | 3/8" | \$4.80 | 120 | 10 | 40 |
| 100-103LH | 1/2" | \$7.18 | 100 | 10 | 50 |
| 100-104LH | 3/4" | \$10.91 | 80 | 10 | 67 |
| 100-105LH | 1" | \$17.14 | 48 | 8 | 58 |
| 100-106LH | 1-1/4" | \$26.28 | 36 | 4 | 68 |
| 100-107LH | 1-1/2" | \$37.19 | 24 | 2 | 61 |
| 100-108LH | 2" | \$56.02 | 12 | 3 | 44 |
| 100-109LH | 2 1/2" | \$129.77 | - | - | - |
| 100-110LH | 3" | \$196.53 | - | - | - |

| Solder | Size | List price | Case | Carton | Weight |
|-----------|--------|------------|------|--------|--------|
| 100-113LH | 1/2" | \$6.52 | 100 | 10 | 45 |
| 100-114LH | 3/4" | \$10.40 | 80 | 10 | 61 |
| 100-115LH | 1" | \$16.23 | 48 | 8 | 53 |
| 100-116LH | 1-1/4" | \$27.62 | 36 | 4 | 68 |
| 100-117LH | 1-1/2" | \$35.91 | 24 | 2 | 62 |
| 100-118LH | 2" | \$57.02 | 12 | 3 | 47 |
| 100-119LH | 2 1/2" | \$132.16 | - | - | - |
| 100-120LH | 3" | \$171.68 | - | - | - |

JFLO
by Jomar

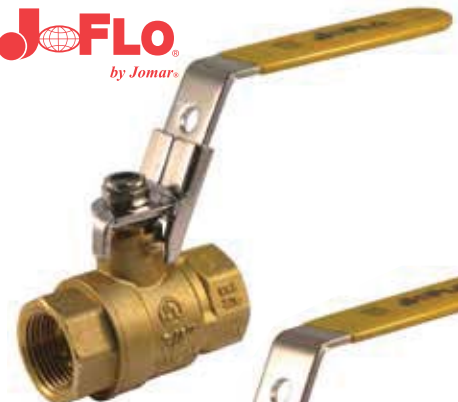

JF-100T-LH



JF-100S-LH

Brass Ball Valves



JF-100TFM

2 Piece • Full Port • Male x Female Connections • 600 WOG

- 1 Buna-N o-ring with Teflon® packing and packing nut
- Blow-out proof stem
- 100% leak tested

Approvals  

| Part # | Size | List price | Case | Carton | Weight |
|---------|------|------------|------|--------|--------|
| 100-131 | 1/4" | \$4.46 | 120 | 10 | 60 |
| 100-132 | 3/8" | \$4.46 | 120 | 10 | 60 |
| 100-133 | 1/2" | \$7.02 | 100 | 10 | 50 |
| 100-134 | 3/4" | \$10.77 | 80 | 10 | 60 |
| 100-135 | 1" | \$16.86 | 48 | 8 | 58 |

| Red T-handle | Size | List price | Case | Carton | Weight |
|--------------|------|------------|------|--------|--------|
| 100-131TH | 1/4" | \$4.79 | 120 | 10 | 60 |
| 100-132TH | 3/8" | \$4.77 | 120 | 10 | 60 |
| 100-133TH | 1/2" | \$7.51 | 100 | 10 | 50 |
| 100-134TH | 3/4" | \$11.51 | 80 | 10 | 60 |
| 100-135TH | 1" | \$18.04 | 48 | 8 | 58 |



JF-100TFM

T-83C

2 Piece • Full Port • 600 WOG

- Large raised wrench flats
- 2 Buna-N o-rings
- 100% leak tested

| 1/4 Turn Handle | Size | List price | Case | Carton | Weight |
|-----------------|---------------------|------------|------|--------|--------|
| 100-397 | 1/8" FIP x 1/8" MIP | \$4.54 | 250 | 25 | 70 |
| 100-398 | 1/4" FIP x 1/8" MIP | \$4.54 | 200 | 20 | 70 |
| 100-399 | 1/4" FIP x 1/4" MIP | \$4.54 | 250 | 25 | 40 |
| 100-400 | 1/4" FIP x 1/4" FIP | \$4.54 | 200 | 20 | 49 |

| T-handle | Size | List price | Case | Carton | Weight |
|-----------|---------------------|------------|------|--------|--------|
| 100-397TH | 1/8" FIP x 1/8" MIP | \$4.54 | 250 | 25 | 70 |
| 100-398TH | 1/4" FIP x 1/8" MIP | \$4.54 | 200 | 20 | 70 |
| 100-399TH | 1/4" FIP x 1/4" MIP | \$4.54 | 250 | 25 | 40 |
| 100-400TH | 1/4" FIP x 1/4" FIP | \$4.54 | 200 | 20 | 49 |



T-83C

Brass Ball Valves

JF-100T-FL

2 Piece • Full Port • Threaded Connection • 600 WOG with Swivel Pump Flange

- For use on flanged end circulation pumps
- 1 Buna-N o-ring with Teflon® packing and packing nut
- Ideal for use on in-floor heating systems
- Swivel flange allows valve to be mounted in any position
- Positional lever handle for easy operation
- 100% leak tested

| Part # | Size | List price | Case | Carton | Weight |
|-----------|--------|------------|------|--------|--------|
| 100-103FL | 1/2" | \$11.74 | 20 | 1 | 25 |
| 100-104FL | 3/4" | \$15.20 | 20 | 1 | 30 |
| 100-105FL | 1" | \$19.76 | 20 | 1 | 35 |
| 100-106FL | 1-1/4" | \$29.15 | 20 | 1 | 40 |

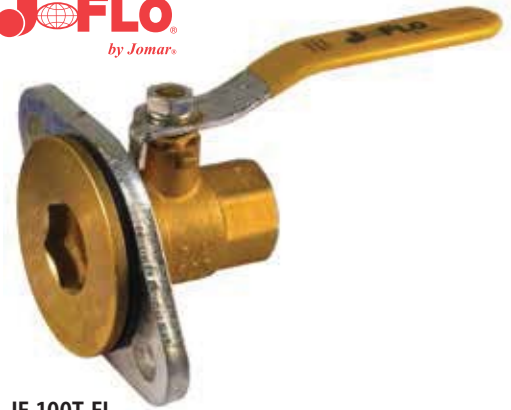

JF-100T-FL

JF-100S-FL

2 Piece • Full Port • Solder Connection • 600 WOG with Swivel Pump Flange

- For use on flanged end circulation pumps
- 1 Buna-N o-ring with Teflon® packing and packing nut
- Ideal for use on in-floor heating systems
- Swivel flange allows valve to be mounted in any position
- Positional lever handle for easy operation
- 100% leak tested

| Part # | Size | List price | Case | Carton | Weight |
|-----------|--------|------------|------|--------|--------|
| 100-113FL | 1/2" | \$11.74 | 20 | 1 | 25 |
| 100-114FL | 3/4" | \$15.20 | 20 | 1 | 30 |
| 100-115FL | 1" | \$19.76 | 20 | 1 | 35 |
| 100-116FL | 1-1/4" | \$29.15 | 20 | 1 | 40 |

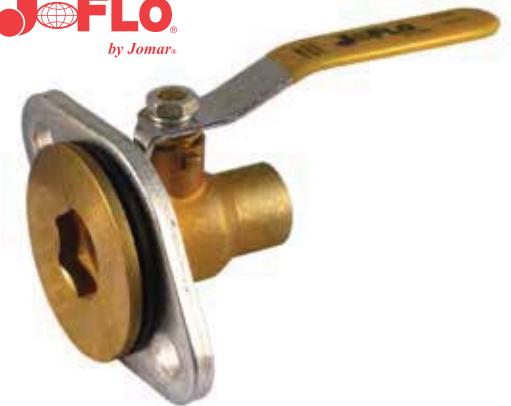

JF-100S-FL

T-110 & S-110

2 Piece • Full Port • 600 WOG • with Drain

- 1 Buna-N o-ring with Teflon® packing and packing nut
- Blow-out proof stem
- Drain feature prevents freeze-up
- 100% leak tested

| Threaded | Size | List price | Case | Carton | Weight |
|----------|------|------------|------|--------|--------|
| 100-633 | 1/2" | \$7.18 | 120 | 10 | 51 |
| 100-634 | 3/4" | \$11.18 | 80 | 10 | 47 |
| 100-635 | 1" | \$17.58 | 36 | 6 | 43 |

| Solder | Size | List price | Case | Carton | Weight |
|---------|------|------------|------|--------|--------|
| 100-643 | 1/2" | \$7.17 | 120 | 10 | 51 |
| 100-644 | 3/4" | \$11.16 | 80 | 10 | 47 |
| 100-645 | 1" | \$17.55 | 48 | 8 | 43 |



T-110

S-110

Brass Ball Valves



C-402

2 Piece • Full Port • Compression Connection • 600 WOG • with Drain

- Drain feature prevents freeze-up
- Eliminates seat damage during soldering
- Compression ends ease maintenance
- 1 Buna-N o-ring with Teflon® packing and packing nut
- Blow-out proof stem
- 100% leak tested

| Part # | Size | List price | Case | Carton | Weight |
|---------|------|------------|------|--------|--------|
| 102-653 | 1/2" | \$7.82 | 120 | 10 | 60 |
| 102-654 | 3/4" | \$12.40 | 90 | 10 | 61 |
| 102-655 | 1" | \$19.06 | 60 | 6 | 71 |



C-402

JFP-100

2 Piece • Full Port • Push-Fit Connection • 200 WOG

- Easy to connect and fit in seconds
- Connects with copper, CPVC and PEX
- Teflon® packing and packing nut
- Includes two pipe reinforcers and release tool
- 100% leak tested

Approvals

| Part # | Size | List price | Case | Carton | Weight |
|------------|------|------------|------|--------|--------|
| 100-103JFP | 1/2" | \$10.81 | 100 | 10 | 39 |
| 100-104JFP | 3/4" | \$16.26 | 100 | 10 | 60 |
| 100-105JFP | 1" | \$28.42 | 50 | 5 | 49 |



JFP-100

T-412 & S-412

2 Piece • Standard Port • Pex Connection • 600 WOG

- Blow-out proof stem design
- 1 Buna-N o-ring with Teflon® packing and packing nut
- 100% leak tested

| PEX x PEX | Size | List price | Case | Carton | Weight |
|-----------|------|------------|------|--------|--------|
| 103-523P | 1/2" | \$4.06 | 120 | 10 | 33 |
| 103-524P | 3/4" | \$6.60 | 120 | 10 | 50 |
| 103-525P | 1" | \$10.75 | 54 | 6 | 37 |

| Solder x PEX | Size | List price | Case | Carton | Weight |
|--------------|------|------------|------|--------|--------|
| 103-533P | 1/2" | \$6.96 | 120 | 10 | 32 |
| 103-534P | 3/4" | \$11.02 | 120 | 10 | 50 |

| MIP x Pex | Size | List price | Case | Carton | Weight |
|-----------|------|------------|------|--------|--------|
| 103-534MP | 3/4" | \$7.29 | 120 | 10 | 50 |



T-412

S-412

Brass Ball Valves

JF-800 Series

Low Pressure Quarter Turn • 200 WOG

| JF-822T | Size | List price | Case | Carton | Weight |
|---------|------|------------|------|--------|--------|
| 211-003 | 1/2" | \$6.31 | 120 | 10 | - |
| 211-004 | 3/4" | \$7.39 | 120 | 10 | - |
| JF-821T | Size | List price | Case | Carton | Weight |
| 211-103 | 1/2" | \$6.05 | 120 | 10 | - |
| 211-104 | 3/4" | \$7.65 | 120 | 10 | - |
| JF-841T | Size | List price | Case | Carton | Weight |
| 212-003 | 1/2" | \$7.18 | 120 | 10 | - |
| 212-004 | 3/4" | \$8.13 | 120 | 10 | - |
| JF-841S | Size | List price | Case | Carton | Weight |
| 212-103 | 1/2" | \$6.70 | 120 | 10 | - |
| 212-104 | 3/4" | \$7.91 | 120 | 10 | - |
| JF-833T | Size | List price | Case | Carton | Weight |
| 211-207 | 1/2" | \$5.88 | 120 | 10 | - |
| 211-208 | 3/4" | \$6.83 | 120 | 10 | - |
| JF-833S | Size | List price | Case | Carton | Weight |
| 211-209 | 1/2" | \$6.74 | 120 | 10 | - |
| JF-832T | Size | List price | Case | Carton | Weight |
| 211-205 | 1/2" | \$5.88 | 120 | 10 | - |
| 211-206 | 3/4" | \$6.92 | 120 | 10 | - |



JF-800 SERIES

TWV-3W-KIT

3 Way Ball • Tankless Water Heater Valve Kit • Standard Port • 600 WOG

- Color coded hot and cold lever handles
- Unique, T.E.A. Ternary Eco Alloy® Coated 3-way style ball
- 2 Viton® o-rings with Teflon® packing and packing nut
- U.S.A. Patent No. 7,762,280 B2
- 3/4" 200,000 BTU/hr pressure relief valve included with kit set to 150 PSI
- 100% leak tested
- Made in Italy
- Leakproof stem - Lifetime Warranty

| Connection | Part # | Size | List price | Case | Carton | Weight |
|------------|---------|------|------------|------|--------|--------|
| Threaded | 810-504 | 3/4" | \$96.74 | 12 | 1 | 48 |
| Sweat | 810-514 | 3/4" | \$96.74 | 12 | 1 | 48 |
| Press | 810-524 | 3/4" | \$121.62 | 12 | 1 | 48 |



TWV-3W-KIT

Individual Tankless Water Heater Valves

| Threaded | Solder | Size | List price | Case | Carton | Weight |
|-------------|-------------|------|------------|------|--------|--------|
| 810-534 (H) | 810-554 (H) | 3/4" | \$51.91 | - | - | - |
| 810-544 (C) | 810-564 (C) | 3/4" | \$51.91 | - | - | - |

Pressure Relief Valve

- Forged brass construction
- Carbon steel pressure spring
- 100% leak tested
- Made in Italy

Approvals

| Part # | Size | List price | Case | Carton | Weight |
|---------|------|------------|------|--------|--------|
| 203-104 | 3/4" | \$12.91 | 100 | - | 48.6 |



PRV

Medical Gas Ball Valves



S-650-CE-4B

**3 Piece 4 Bolt • Cleaned for Medical Gas • Copper Stub Connection
600 WOG**

- NFPA-99C standard
- "K" copper tubing extensions silver brazed
- Latch lock handle is standard
- Oxygen cleaned
- 100% leak tested

| Part # | Size | List price | Case | Carton | Weight |
|---------|--------|------------|------|--------|--------|
| 500-803 | 1/2" | \$115.18 | 1 | 1 | - |
| 500-804 | 3/4" | \$158.74 | 1 | 1 | - |
| 500-805 | 1" | \$213.33 | 1 | 1 | - |
| 500-806 | 1-1/4" | \$278.68 | 1 | 1 | - |
| 500-807 | 1-1/2" | \$393.52 | 1 | 1 | - |
| 500-808 | 2" | \$851.24 | 1 | 1 | - |



S-650-CE-4B



Repair Kits Available

S-675-GP-4B

**3 Piece 4 Bolt • Cleaned for Medical Gas • Copper Stub Connection
with Single Gauge Port • 600 WOG**

- NFPA-99C standard
- 1/8" gauge purge port
- "K" copper tubing extensions silver brazed
- Latch lock handle is standard
- Oxygen cleaned
- 100% leak tested

| Part # | Size | List price | Case | Carton | Weight |
|---------|--------|------------|------|--------|--------|
| 500-823 | 1/2" | \$122.41 | 1 | 1 | - |
| 500-824 | 3/4" | \$167.06 | 1 | 1 | - |
| 500-825 | 1" | \$223.80 | 1 | 1 | - |
| 500-826 | 1-1/4" | \$292.23 | 1 | 1 | - |
| 500-827 | 1-1/2" | \$412.31 | 1 | 1 | - |
| 500-828 | 2" | \$898.80 | 1 | 1 | - |



S-675-GP-4B



Repair Kits Available

S-675-DGP-4B

**3 Piece 4 Bolt • Cleaned for Medical Gas • Copper Stub Connection
with Double Gauge Port • 600 WOG**

- NFPA-99C standard
- Two 1/8" gauge purge ports
- "K" copper tubing extensions silver brazed
- Latch lock handle is standard
- Oxygen cleaned
- 100% leak tested

| Part # | Size | List price | Case | Carton | Weight |
|---------|--------|------------|------|--------|--------|
| 500-833 | 1/2" | \$129.54 | 1 | 1 | - |
| 500-834 | 3/4" | \$177.05 | 1 | 1 | - |
| 500-835 | 1" | \$241.87 | 1 | 1 | - |
| 500-836 | 1-1/4" | \$318.15 | 1 | 1 | - |
| 500-837 | 1-1/2" | \$438.94 | 1 | 1 | - |
| 500-838 | 2" | \$913.07 | 1 | 1 | - |



S-675-DGP-4B



Repair Kits Available

Add-A-Valve®



Add-A-Valve® Emergency Shut Off Device

- Eliminates facility shutdowns
- Bottom cleanout cap serves as line tap
- Lead free S-100C ball valve included in package
- Loc-Tite® gasket sealant included
- U.S. and Canadian patent no. 5,316,037



| Part # | Size | List price | Case | Carton | Weight |
|------------|--------|------------|------|--------|--------|
| 800-103ADD | 1/2" | \$282.62 | 3 | 1 | 3 |
| 800-104ADD | 3/4" | \$358.79 | 4 | 1 | 4 |
| 800-105ADD | 1" | \$510.18 | 6 | 1 | 6 |
| 800-106ADD | 1-1/4" | \$807.46 | 10 | 1 | 10 |
| 800-107ADD | 1-1/2" | \$1,005.67 | 13 | 1 | 13 |
| 800-108ADD | 2" | \$1,554.39 | 21 | 1 | 21 |

This is a basic step-by-step installation for sizes 1/2" - 1"



Clean Pipe

Apply Sealant

Merge Halves

Test for Leaks

Ratchet
Stem Cutter

Stop Flow

Gas Ball Valves

T-204DU

2 Piece • Dielectric Union End • 600 WOG

- Meets NFPA 58, Section 6.9.3.16 dielectric union requirement
- Valve can be locked in the closed position by reversing the handle
- 2 Viton® o-rings
- 100% leak tested
- Made in Italy
- Leakproof stem - Lifetime Warranty

Approvals  

| FIP UE x Flare | Size | List price | Case | Carton | Weight |
|----------------|-------------|------------|------|--------|--------|
| 101-513DU | 1/2" x 1/2" | \$16.88 | 80 | 8 | - |

| FIP UE x FIP | Size | List price | Case | Carton | Weight |
|--------------|-------------|------------|------|--------|--------|
| 101-403DU | 1/2" x 1/2" | \$16.88 | 80 | 8 | - |
| 101-404DU | 3/4" x 3/4" | \$28.26 | 80 | 8 | - |

| MIP UE x Flare | Size | List price | Case | Carton | Weight |
|----------------|-------------|------------|------|--------|--------|
| 101-703DU | 1/2" x 1/2" | \$17.56 | 80 | 8 | - |

| MIP UE x FIP | Size | List price | Case | Carton | Weight |
|--------------|-------------|------------|------|--------|--------|
| 101-803DU | 1/2" x 1/2" | \$17.56 | 80 | 8 | - |
| 101-804DU | 3/4" x 3/4" | \$29.93 | 80 | 8 | - |



T-204DU
FIP UE X FLARE



T-204DU
FIP UE X FIP



T-204DU
MIP UE X FLARE



T-204DU
MIP UE X FIP



Gas Ball Valves



T-204

2 Piece • 600 WOG

- Valve can be locked in the closed position by reversing the handle
- T-handle and teardrop handle available
- 2 Viton® o-rings
- 100% leak tested
- Made in Italy
- Leakproof stem - Lifetime Warranty

Approvals

| FIP x FIP | | Size | List price | Case | Cart | Weight |
|------------|----------|------|------------|------|------|--------|
| T-handle | Teardrop | | | | | |
| 101-401 | 101-411 | 1/4" | \$10.43 | 120 | 12 | 43 |
| 101-402 | 101-412 | 3/8" | \$11.03 | 120 | 12 | 40 |
| 101-403 | 101-413 | 1/2" | \$8.16 | 120 | 12 | 53 |
| 101-403NH | - | 1/2" | \$7.78 | 120 | 12 | 53 |
| 101-404 | 101-414 | 3/4" | \$13.56 | 120 | 12 | 74 |
| 101-404BRT | - | 3/4" | \$20.34 | 120 | 12 | 74 |

For sizes above 3/4" use T-100C

| Flare x FIP | | Size | List price | Case | Cart | Weight |
|-------------|----------|-------------|------------|------|------|--------|
| T-handle | Teardrop | | | | | |
| 101-502 | 101-512 | 1/2" x 3/8" | \$10.83 | 140 | 14 | 59 |
| 101-503 | 101-513 | 1/2" x 1/2" | \$10.83 | 140 | 14 | 62 |
| 101-504 | - | 3/4" x 5/8" | \$15.46 | 140 | 14 | - |

| Flare x Flare | | Size | List price | Case | Cart | Weight |
|---------------|----------|-------------|------------|------|------|--------|
| Teardrop | Teardrop | | | | | |
| 101-601 | - | 1/2" x 3/8" | \$11.92 | 120 | 12 | 50 |
| 101-602 | 101-612 | 3/8" x 3/8" | \$10.83 | 120 | 12 | 48 |
| 101-603 | 101-613 | 1/2" x 1/2" | \$10.83 | 120 | 12 | 52 |
| 101-604 | 101-614 | 5/8" x 5/8" | \$15.87 | 120 | 12 | 74 |

| MIP x Flare | | Size | List price | Case | Carton | Weight |
|-------------|----------|-------------|------------|------|--------|--------|
| T-handle | Teardrop | | | | | |
| 101-702 | - | 1/2" x 3/8" | \$10.83 | 120 | 12 | 61 |
| 101-703 | - | 1/2" x 1/2" | \$10.83 | 120 | 12 | 64 |



T-204
FIP X FIP



T-204
FIP X FLARE



T-204
FLARE X FLARE



T-204
MIP X FLARE

Gas Ball Valves

NEW

T-203DU

2 Piece • Dielectric Union End • 600 WOG • with Side Tap

- Meets NFPA 58, Section 6.9.3.16 dielectric union requirement
- Eliminates need for test tee and labor to install
- Removable plug enables port for pressure gauge
- Valve can be locked in the closed position by reversing the handle
- 2 Viton® o-rings
- 1/8" side tap
- 100% leak tested
- Made in Italy
- Leakproof stem - Lifetime Warranty

Approvals

| MIP UE x FIP | Size | List price | Case | Carton | Weight |
|--------------|------|------------|------|--------|--------|
| 102-303DU | 1/2" | \$23.06 | 80 | 8 | - |
| 102-304DU | 3/4" | \$33.09 | 80 | 8 | - |

| MIP UE x Flare | Size | List price | Case | Carton | Weight |
|----------------|------|------------|------|--------|--------|
| 102-403DU | 1/2" | \$33.09 | 80 | 8 | - |

| FIP UE x FIP | Size | List price | Case | Carton | Weight |
|--------------|------|------------|------|--------|--------|
| 102-313DU | 1/2" | \$33.09 | 80 | 8 | - |
| 102-314DU | 3/4" | \$33.09 | 80 | 8 | - |

| FIP UE x Flare | Size | List price | Case | Carton | Weight |
|----------------|------|------------|------|--------|--------|
| 102-413DU | 1/2" | \$33.09 | 80 | 8 | - |



T-203

2 Piece • 600 WOG • with Side Tap

- Eliminates need for test tee and labor to install
- Removable plug enables port for pressure gauge
- Valve can be locked in the closed position by reversing the handle
- 2 Viton® o-rings
- 1/8" side tap
- 100% leak tested
- Made in Italy
- Leakproof stem - Lifetime Warranty

Approvals

| FIP x FIP | Size | List price | Case | Carton | Weight |
|-----------|------|------------|------|--------|--------|
| 102-301 | 1/4" | \$13.98 | 100 | 10 | 44 |
| 102-302 | 3/8" | \$13.98 | 100 | 10 | 43 |
| 102-303 | 1/2" | \$13.98 | 100 | 10 | 42 |
| 102-304 | 3/4" | \$17.75 | 100 | 10 | 63 |

For sizes above 3/4" use T-100STN

| Flare x Flare | Size | List price | Case | Carton | Weight |
|---------------|------|------------|------|--------|--------|
| 102-402 | 3/8" | \$16.78 | 150 | 15 | 67 |
| 102-403 | 1/2" | \$16.78 | 120 | 12 | 59 |
| 102-404 | 5/8" | \$23.44 | 100 | 10 | 67 |

| Flare x FIP | Size | List price | Case | Carton | Weight |
|-------------|------|------------|------|--------|--------|
| 102-405 | 1/2" | \$20.80 | 100 | 10 | 67 |



Gas Ball Valves



T-205

2 Piece • 400 WOG

- Valve can be locked in the closed position by reversing the handle
- 2 Viton® o-rings with Teflon® packing and packing nut
- 100% leak tested
- Made in Italy
- Leakproof stem - Lifetime Warranty

Approvals

| Red T-Handle | Size | List price | Case | Carton | Weight |
|--------------|------|------------|------|--------|--------|
| 102-503 | 1/2" | \$8.03 | 160 | 16 | 58 |
| 102-504 | 3/4" | \$11.25 | 120 | 12 | 64 |
| 102-505 | 1" | \$18.35 | 72 | 12 | 67 |

| Yellow Teardrop | Size | List price | Case | Carton | Weight |
|-----------------|------|------------|------|--------|--------|
| 102-513 | 1/2" | \$8.03 | 120 | 12 | 43 |
| 102-514 | 3/4" | \$11.25 | 100 | 10 | 53 |



T-205
T-HANDLE

T-205
TEARDROP HANDLE

T-2005C

2 Piece

- Valve can be locked in the open or closed position by reversing the handle
- 1 Buna-N o-ring with Teflon® packing and packing nut
- 100% leak tested

Approvals

| Part # | Size | List price | Case | Carton | Weight |
|---------|------|------------|------|--------|--------|
| 102-603 | 1/2" | \$5.07 | 100 | 10 | 39 |
| 102-604 | 3/4" | \$7.57 | 100 | 10 | 52 |
| 102-605 | 1" | \$11.73 | 60 | 6 | 51 |



T-2005C

T-2004C

2 Piece • Flare Connection

- Valve can be locked in the closed position by reversing the handle
- 1 Buna-N o-ring with Teflon® packing and packing nut
- Plastic caps to protect flare connection and threads
- Buna-N o-ring
- 100% leak tested

Approvals

| Part # | Size | List price | Case | Carton | Weight |
|---------|------|------------|------|--------|--------|
| 102-612 | 3/8" | \$5.04 | 100 | 10 | 39 |
| 102-613 | 1/2" | \$5.66 | 100 | 10 | 52 |
| 102-614 | 5/8" | \$8.12 | 60 | 6 | 51 |



T-2004C

Lockwings

175-LWN

Utility Gas Ball Valve • Full Port • 175 PSIG

- Tamper resistant locking cap
- 2 Viton® o-rings
- 100% leak tested
- Made in Italy
- Leakproof stem - Lifetime Warranty

Approvals

| Part # | Size | List price | Case | Carton | Weight |
|---------------|--------|------------|------|--------|--------|
| 240-003B | 1/2" | \$25.40 | 40 | 10 | 52 |
| 240-003P | 1/2" | \$31.65 | 40 | 10 | 52 |
| 240-004B | 3/4" | \$28.34 | 40 | 10 | 52 |
| 240-004P or T | 3/4" | \$31.09 | 40 | 10 | 52 |
| 240-005B | 1" | \$39.69 | 24 | 6 | 50 |
| 240-005P or T | 1" | \$43.16 | 24 | 6 | 50 |
| 240-006B | 1-1/4" | \$71.85 | 16 | 4 | 48 |
| 240-006P or T | 1-1/4" | \$81.30 | 16 | 4 | 48 |
| 240-007B | 1-1/2" | \$104.69 | 12 | 3 | 48 |
| 240-007P or T | 1-1/2" | \$114.98 | 12 | 3 | 48 |
| 240-008B | 2" | \$139.57 | 8 | 2 | 48 |
| 240-008P or T | 2" | \$153.45 | 8 | 2 | 48 |

B = Brass, P = Painted, T = TEA Coated



175-LWN
BRASS



175-LWN
PAINTED



175-LWN
T.E.A. COATED

125-LWN

Utility Gas Ball Valve • Full Port • 125 PSIG

- Tamper resistant locking cap
- 2 Viton® o-rings
- 100% leak tested
- Made in Italy
- Leakproof stem - Lifetime Warranty

Approvals

| FIP x FIP | Size | List price | Case | Carton | Weight |
|-----------|------|------------|------|--------|--------|
| 242-004B | 3/4" | \$23.51 | 40 | 10 | 52 |
| 242-004P | 3/4" | \$27.10 | 40 | 10 | 52 |
| 242-005B | 1" | \$34.22 | 24 | 6 | 50 |
| 242-005P | 1" | \$35.15 | 24 | 6 | 50 |

| MIP x FIP | Size | List price | Case | Carton | Weight |
|-----------|------|------------|------|--------|--------|
| 246-005B | 1" | \$36.54 | 20 | 5 | 36 |

B = Brass, P = Painted



125-LWN FIP X FIP
BRASS



125-LWN FIP X FIP
PAINTED



125-LWN MIP X FIP
BRASS

Lockwings

175-LWIN

Utility Gas Ball Valve • Full Port • 175 PSIG with Insulated Tail Piece

- Tamper resistant lockwing cap
- 2 Viton® o-rings
- 100% leak tested
- Made in Italy
- Leakproof stem - Lifetime Warranty

Approvals

| Part # | Size | List price | Case | Carton | Weight |
|---------------|--------|------------|------|--------|--------|
| 241-004D | 3/4" | \$50.71 | 30 | 5 | 58 |
| 241-004P or T | 3/4" | \$56.78 | 30 | 5 | 58 |
| 241-005B | 1" | \$58.21 | 16 | 4 | 51 |
| 241-005P or T | 1" | \$62.87 | 16 | 4 | 51 |
| 241-006D | 1-1/4" | \$91.24 | 12 | 3 | 51 |
| 241-006P or T | 1-1/4" | \$100.43 | 12 | 3 | 51 |

D/B = Brass, P = Painted, T = TEA Coated

| Ext. Male Tailpiece | Size | List price | Case | Carton | Weight |
|---------------------|------|------------|------|--------|--------|
| 241-004EUM | 3/4" | \$14.92 | 1 | 1 | - |



125-LWBP

Utility Gas Ball Valve • Full Port • Service Bypass • 125 PSIG

- Tamper resistant lockwing cap
- 2 Viton® o-rings
- 100% leak tested
- Made in Italy
- Leakproof stem - Lifetime Warranty
- Patented security shutter and lockwing tab
 - US Patent no. 6,648,009

| Part # | Size | List price | Case | Carton | Weight |
|----------|------|------------|------|--------|--------|
| 244-005B | 1" | \$46.60 | 20 | 5 | 39 |
| 244-005P | 1" | \$49.35 | 20 | 5 | 39 |

B = Brass, P = Painted



Lockwings

175-LWBP

Utility Gas Ball Valve • Full Port • Service Bypass • 175 PSIG

- Tamper resistant lockwing cap
- 2 Viton® o-rings
- 100% leak tested
- Made in Italy
- Leakproof stem - Lifetime Warranty
- Patented security shutter and lockwing tab
 - US Patent no. 6,648,009

| Part # | Size | List price | Case | Carton | Weight |
|----------|------|------------|------|--------|--------|
| 244-004B | 3/4" | \$36.51 | 20 | 5 | - |



175-LWBP

175-LWIBP

Utility Gas Ball Valve • Full Port • Service Bypass • 175 PSIG with Insulated Tail Piece

- Tamper resistant lockwing cap
- 2 Viton® o-rings
- 100% leak tested
- Made in Italy
- Leakproof stem - Lifetime Warranty
- Patented security shutter and lockwing tab
 - US Patent no. 6,648,009

| Part # | Size | List price | Case | Carton | Weight |
|----------|------|------------|------|--------|--------|
| 243-004D | 3/4" | \$59.48 | 20 | 5 | 39 |
| 243-004P | 3/4" | \$62.22 | 20 | 5 | 39 |

D = Brass, P = Painted

| 175-LWIBP-EXT | Size | List price | Case | Carton | Weight |
|---------------|------|------------|------|--------|--------|
| 243-004EXT | 3/4" | \$65.03 | 1 | 1 | - |



175-LWIBP



175-LWIBP-EXT



Replacement o-rings, union nuts and tailpieces available upon request

125-LWUBP

Utility Gas Ball Valve • Full Port • Service Bypass • 125 PSIG with Union Tail Piece

- Tamper resistant lockwing cap
- 2 Viton® o-rings
- 100% leak tested
- Made in Italy
- Leakproof stem - Lifetime Warranty
- Patented security shutter and lockwing tab
 - US Patent no. 6,648,009

| Part # | Size | List price | Case | Carton | Weight |
|----------|------|------------|------|--------|--------|
| 244-105B | 1" | \$58.90 | 20 | 5 | 42 |
| 244-105P | 1" | \$61.64 | 20 | 5 | 42 |

B = Brass, P = Painted



125-LWUBP



Replacement o-rings, union nuts and tailpieces available upon request

175-LWIBP Commercial Bypass

Utility Gas Ball Valve • Full Port • Service Bypass • 175 PSIG
with Insulated Tail Piece

- Tamper resistant lockwing cap
- 2 Viton® o-rings
- 100% leak tested
- Made in Italy
- Leakproof stem - Lifetime Warranty

| Part # | Size | List price | Case | Carton | Weight |
|----------|--------|------------|------|--------|--------|
| 243-006B | 1-1/4" | \$90.76 | 1 | 1 | 13 |



175-LWIBP COMMERCIAL BYPASS



Replacement o-rings, union nuts and tailpieces available upon request

175-LWBP Commercial Bypass

Utility Gas Ball Valve • Full Port • Service Bypass • 175 PSIG

- Tamper resistant lockwing cap
- 2 Viton® o-rings
- 100% leak tested
- Made in Italy
- Leakproof stem - Lifetime Warranty
- Meets or exceeds applicable part of DOT 192 and ANSI B16.33
- Threads conform to ANSI B1.20.1

| Part # | Size | List price | Case | Carton | Weight |
|----------|------|------------|------|--------|--------|
| 244-008B | 2" | \$162.16 | 1 | 1 | 30 |



175-LWBP COMMERCIAL BYPASS

Bypass Key

| Part # | List price | Case | Carton | Weight |
|----------|------------|------|--------|--------|
| 243-004K | \$14.55 | 1 | 1 | 0.14 |



BYPASS KEY

Thread Sealant

Gimme the White Stuff™

Slow-Drying Soft-Set PTFE Thread Sealant

An all purpose PTFE thread sealing compound that produces leakproof seals on threaded connections. Lubricates, seals and protects threads in an extensive variety of plumbing, heating and oil field threaded pipe connections over a wide range of services, temperatures and pressures. Will not dry out, stain, harden or separate. Non-toxic. Will not destroy the seals of valves or faucets. Wipes clean from hands easily.

Approvals

| Part # | Size | List price | Case | Weight |
|---------|------------|------------|------|--------|
| 400-001 | 2 oz. tube | \$3.62 | 72 | 11 |
| 400-002 | 4 oz can | \$6.93 | 24 | 13 |
| 400-003 | 8 oz can | \$12.60 | 24 | 20 |
| 400-004 | 16 oz can | \$19.67 | 12 | 22 |
| 400-005 | 32 oz can | \$36.17 | 12 | 39 |



GIMME THE WHITE STUFF

Recommended Uses

- Acids, Diluted
- Air, Compressed Gaseous
- Alkalis, Diluted
- Ammonia
- Aliphatic Solvents
- Brine
- Butane
- Carbon Dioxide
- Castor Oils
- Chlorinated Water
- Corrosives
- Coal Tar Naphtha
- Cutting Oils
- Diesel Fuel Oil
- Fatty Acids (Liquids)
- Freon (All)
- Gasoline
- Gasohol
- Glycol
- Heating Oils
- Helium Gaseous
- Hydraulic Oils
- Hydrogen
- Inert Gases, Gaseous
- Jet Fuel (JP 3,4,5)
- Kerosene
- Lacquer
- Liquefied Petroleum Gases
- Manufactured Gases
- Mineral Oils
- Naphtha
- Natural Gas
- Nitrogen, Gaseous
- Petroleum Solvents
- Propane
- Refrigeration Gases
- Soap, Liquid
- Steam Lines
- Sugar, Liquid
- Vegetable Oils
- Water (Hot or Cold)
- Xylol

NOT FOR USE ON OXYGEN

Gimme the Green Stuff™

Slow-Drying Soft-Set Thread Sealant

Slow drying, soft setting, non-hardening pipe thread compound. Recommended for on-site or assembly line work. Lead free and non-toxic. Will not harden in can. Will not dry out, stain, harden or separate. Will not destroy the seals of valves or faucets. Wipes clean from hands easily.

Approvals

| Part # | Size | List price | Case | Weight |
|---------|------------|------------|------|--------|
| 400-101 | 2 oz. tube | \$3.48 | 72 | 11 |
| 400-102 | 4 oz can | \$6.79 | 24 | 13 |
| 400-103 | 8 oz can | \$11.55 | 24 | 20 |
| 400-104 | 16 oz can | \$18.44 | 12 | 22 |
| 400-105 | 32 oz can | \$34.30 | 12 | 39 |



GIMME THE GREEN STUFF

Recommended Uses

- Acids, Diluted
- Air, Compressed Gaseous
- Alkalis, Diluted
- Ammonia
- Aliphatic Solvents
- Brine
- Butane
- Carbon Dioxide
- Castor Oils
- Chlorinated Water
- Coal Tar Naphtha
- Cutting Oils
- Diesel Fuel Oil
- Freon (All)
- Gasoline
- Glycol
- Heating Oils
- Helium Gaseous
- Hydraulic Oils
- Hydrogen
- Inert Gases, Gaseous
- Jet Fuel (JP 3,4,5)
- Kerosene
- Lacquer
- Liquefied Petroleum Gases
- Manufactured Gases
- Mineral Oils
- Natural Gas
- Nitrogen, Gaseous
- Petroleum Solvents
- Propane
- Refrigeration Gases
- Soap, Liquid
- Steam Lines
- Sugar, Liquid
- Vegetable Oils
- Water (Hot or Cold)

NOT FOR USE ON OXYGEN

Thread Sealant



The Heavyweight®

Slow-Drying Soft-Set Extra PTFE Thread Sealant

An all purpose heavy duty thread sealing compound that produces leakproof seals on threaded connections. Lubricates and protects threads in an extensive variety of industrial, chemical and oil field threaded pipe connections over a wide range of temperatures and pressures. Its low coefficient of friction allows tighter make-up with low torque, seals permanently and has excellent compressibility. Will not destroy the seals of valves or faucets. Wipes clean from hands easily.

Approvals

| Part # | Size | List price | Case | Weight |
|---------|------------|------------|------|--------|
| 400-201 | 2 oz. tube | \$4.69 | 72 | 11 |
| 400-202 | 4 oz can | \$12.10 | 24 | 13 |
| 400-203 | 8 oz can | \$21.52 | 24 | 20 |
| 400-204 | 16 oz can | \$31.59 | 12 | 22 |
| 400-205 | 32 oz can | \$54.66 | 12 | 39 |



THE HEAVYWEIGHT

Recommended Uses

- Acids, Diluted
- Air, Compressed Gaseous
- Alkalis, Diluted
- Ammonia
- Aliphatic Solvents
- Brine
- Butane
- Carbon Dioxide
- Castor Oils
- Chlorinated Water
- Corrosives
- Coal Tar Naphtha
- Cutting Oils
- Diesel Fuel Oil
- Fatty Acids (Liquids)
- Freon (All)
- Gasoline
- Gasohol
- Glycol
- Heating Oils
- Helium Gaseous
- Hydraulic Oils
- Hydrogen
- Inert Gases, Gaseous
- Jet Fuel (JP 3,4,5)
- Kerosene
- Lacquer
- Liquefied Petroleum Gases
- Manufactured Gases
- Mineral Oils
- Naphtha
- Natural Gas
- Nitrogen, Gaseous
- Petroleum Solvents
- Propane
- Refrigeration Gases
- Soap, Liquid
- Steam Lines
- Sugar, Liquid
- Vegetable Oils
- Water (Hot or Cold)
- Xylol

NOT FOR USE ON OXYGEN

WOG Plus

Fast-Drying Hard-Set Water, Oil & Gas Thread Sealant

A rust colored cohesive, smooth flowing liquid, containing an alcohol solution, pigmented with iron oxide, organic gums and resin. It is lead free and free of halogens. W.O.G. Plus is not a strong sensitizer, it is non-corrosive and is a high quality/high performance resin compound, with built-in elasticity that resists vibration and temperature change. W.O.G. Plus is fast drying, flex/hard set, brushable and cures by solvent evaporation.

| Part # | Size | List price | Case | Weight |
|---------|-----------|------------|------|--------|
| 400-302 | 4 oz can | \$7.88 | 24 | 12 |
| 400-303 | 8 oz can | \$10.64 | 24 | 21 |
| 400-304 | 16 oz can | \$17.14 | 12 | 19 |
| 400-305 | 32 oz can | \$26.84 | 12 | 38 |



WOG PLUS

Recommended Uses

- Acids, Diluted
- Air, Compressed Gaseous
- Alkalis, Diluted
- Ammonia
- Aliphatic Solvents
- Brine
- Butane
- Carbon Dioxide
- Castor Oils
- Chlorinated Water
- Cutting Oils
- Diesel Fuel Oil
- Freon (All)
- Gasoline
- Heating Oils
- Hydraulic Oils
- Inert Gases, Gaseous
- Jet Fuel (JP 3,4,5)
- Kerosene
- Lacquer
- Liquefied Petroleum Gases
- Manufactured Gases
- Mineral Oils
- Naphtha
- Natural Gas
- Nitrogen, Gaseous
- Petroleum Solvents
- Propane
- Refrigeration Gases
- Soap, Liquid
- Steam Lines
- Sugar, Liquid
- Vegetable Oils
- Water (Hot or Cold)
- Xylol

**NOT FOR USE ON OXYGEN
NOT RECOMMENDED FOR USE
ON ETHANOL**

Thread Sealant

Hi-Temp™

Slow-Drying Soft-Set High Temperature Thread Sealant

Hi-Temp™ is an extreme service colloidal copper anti-seize thread sealant and lubricates the threads at an effective temperature of up to 1800°F. This thread sealing compound is made with the highest quality materials. All information is based on our laboratory testing, independent laboratory test results and actual field experience. When properly used, this material will perform as stated. Since we are unable to control conditions for which the product is being used, our only obligation will be the replacement of the compound.



HI-TEMP

| Part # | Size | List price | Case | Weight |
|---------|-----------|------------|------|--------|
| 400-403 | 8 oz can | \$18.26 | 24 | 19 |
| 400-404 | 16 oz can | \$25.16 | 12 | 15 |

Recommended Uses

- Air, Compressed Gaseous
- Chlorinated Water
- Natural Gas
- Sugar, Liquid
- Alkalis, Diluted
- Corrosives
- Nitrogen, Gaseous
- Water (Hot or Cold)
- Ammonia
- Fatty Acids (Liquids)
- Refrigeration Gases
- NOT FOR USE ON OXYGEN**
- Brine
- Freon (All)
- Soap, Liquid
- Carbon Dioxide
- Inert Gases, Gaseous
- Steam Lines

Y-Strainer

Y-Strainer

Cast Iron Y-Strainer • Flanged Connection • 200 WOG with Stainless Steel Screen

- 304 perforated screens
- (3) additional accessory taps
- Flanges - ANSI 125lbs
- Standard screens:
 - 2-1/2" - 4": 1/16 perforations
 - 6 - 8": 1/8 perforations



Y-STRAINER

| Part # | Size | List price | Carton | Weight |
|---------|--------|------------|--------|--------|
| 600-309 | 2-1/2" | \$169.26 | 1 | 32 |
| 600-310 | 3" | \$201.40 | 1 | 38 |
| 600-311 | 4" | \$333.32 | 1 | 67 |
| 600-313 | 6" | \$709.93 | 1 | 138 |
| 600-314 | 8" | CALL | 1 | 275 |

Butterfly Valves

BFV-Lug

Lug Style • Epoxy-Coated Ductile Iron Body

- Designed for commercial and industrial applications up to 225 PSI. Easily accepts actuator with ISO 5211 mounting flange
- Available in EPDM, PTFE, Buna, or Viton seats
- Meets API 609 & MSS SP-67
- Seat to flange seal eliminates the need for flange gaskets
- Series 600 Lug bodies are bidirectional for dead end service
- With downstream flange, pressure ratings are 2" - 12" = 175PSI, 14" - 24" = 150PSI
- With no downstream flange, bidirectional, dead end service rating are 2" - 12" = 75PSI, 14" - 24" = 50PSI
- Epoxy coated finish
- Ideal for mounting pneumatic/electrical actuators
- Square stem for direct mount



| Part # | Size | EPDM | BUNA-N | PTFE | VITON | Weight |
|-------------|--------|------------|------------|------------|------------|--------|
| 600-02DS_L | 2" | \$72.71 | \$72.71 | \$93.44 | \$141.70 | 10.36 |
| 600-212DS_L | 2-1/2" | \$88.72 | \$88.72 | \$118.96 | \$177.89 | 11.24 |
| 600-03DS_L | 3" | \$100.20 | \$100.20 | \$138.39 | \$217.46 | 12.34 |
| 600-04DS_L | 4" | \$148.69 | \$148.69 | \$195.05 | \$306.18 | 21.82 |
| 600-05DS_L | 5" | \$189.96 | \$189.96 | \$247.73 | \$393.86 | 28.32 |
| 600-06DS_L | 6" | \$245.25 | \$245.25 | \$324.49 | \$481.50 | 35.60 |
| 600-08DS_B | 8" | \$388.54 | \$388.54 | \$511.22 | \$688.89 | 45.96 |
| 600-10DS_B | 10" | \$613.47 | \$613.47 | \$760.89 | \$1,047.89 | 59.08 |
| 600-12DS_B | 12" | \$923.92 | \$923.92 | \$1,240.27 | \$1,431.05 | 88.18 |
| 600-14DS_B | 14" | \$1,203.86 | \$1,205.16 | \$1,703.27 | \$1,780.96 | 123.46 |
| 600-16DS_B | 16" | \$1,806.00 | \$1,810.16 | \$2,396.24 | \$2,770.89 | 211.64 |
| 600-18DS_B | 18" | \$2,498.67 | \$2,504.58 | \$3,365.78 | \$3,673.37 | 268.96 |
| 600-20DS_B | 20" | \$3,368.27 | \$3,375.63 | \$4,726.02 | \$4,888.56 | 445.33 |
| 600-24DS_B | 24" | \$5,097.51 | \$5,110.36 | \$7,539.12 | \$7,366.65 | 595.25 |
| 600-30DS_B | 30"U | Call | Call | Call | Call | |
| 600-36DS_B | 36"U | Call | Call | Call | Call | |

| Ordering Guide | |
|----------------|----------|
| 600-02DS | E-EPDM |
| | B-BUNA-N |
| | P-PTFE |
| | V-Viton |

2-6" comes with (L) lever handle, 8-36" come with (B) bare stem

Butterfly Valve Handle

Lever Handle

Ten-position Lockable Lever Handle

Ships standard on butterfly valves up to 6". Can be equipped to any butterfly valve.

| Part # | Size | List price | Carton | Weight |
|--------|--------|------------|--------|--------|
| BLH2-3 | 2", 3" | \$14.74 | 1 | 1.98 |
| BLH4 | 4" | \$14.74 | 1 | 1.98 |
| BLH5-6 | 5", 6" | \$14.74 | 1 | 4.29 |
| BLH8 | 8" | \$27.96 | 1 | 5.84 |
| BLH10 | 10" | \$33.67 | 1 | 5.84 |
| BLH12 | 12" | \$33.81 | 1 | 5.84 |



LEVER HANDLE

Butterfly Valves

BFV-Wafer

Wafer Style • Epoxy-Coated Ductile Iron Body

- Designed for commercial and industrial applications up to 225 PSI. Easily accepts actuator with ISO 5211 mounting flange
- Available in EPDM, PTFE, Buna, or Viton seats
- Meets API 609 & MSS SP-67
- Seat to flange seal eliminates the need for flange gaskets
- Epoxy coated finish
- Ideal for mounting pneumatic/electrical actuators
- Square stem for direct mount

| Part # | Size | EPDM | BUNA-N | PTFE | VITON | Weight |
|-------------|--------|------------|------------|------------|------------|---------|
| 900-02DS_L | 2" | \$66.84 | \$66.84 | \$87.27 | \$135.98 | 7.49 |
| 900-212DS_L | 2-1/2" | \$80.92 | \$80.92 | \$110.64 | \$170.09 | 9.03 |
| 900-03DS_L | 3" | \$93.22 | \$93.22 | \$131.15 | \$210.10 | 10.36 |
| 900-04DS_L | 4" | \$130.11 | \$130.11 | \$175.21 | \$287.60 | 12.78 |
| 900-05DS_L | 5" | \$168.08 | \$168.08 | \$224.40 | \$372.01 | 19.72 |
| 900-06DS_L | 6" | \$215.30 | \$215.30 | \$293.10 | \$452.15 | 21.49 |
| 900-08DS_B | 8" | \$356.67 | \$356.67 | \$478.23 | \$657.98 | 34.94 |
| 900-10DS_B | 10" | \$551.05 | \$551.05 | \$692.90 | \$984.10 | 42.33 |
| 900-12DS_B | 12" | \$851.54 | \$851.54 | \$1,163.07 | \$1,358.68 | 71.65 |
| 900-14DS_B | 14" | \$1,045.26 | \$1,046.59 | \$1,534.11 | \$1,622.39 | 91.05 |
| 900-16DS_B | 16" | \$1,531.07 | \$1,535.23 | \$2,103.00 | \$2,495.96 | 134.48 |
| 900-18DS_B | 18" | \$2,159.21 | \$2,165.12 | \$3,003.76 | \$3,333.98 | 174.16 |
| 900-20DS_B | 20" | \$2,866.15 | \$2,873.51 | \$4,190.39 | \$4,386.37 | 282.19 |
| 900-24DS_B | 24" | \$4,665.39 | \$4,678.28 | \$7,078.20 | \$6,934.53 | 414.47 |
| 900-30DS_B | 30"U | Call | Call | Call | Call | 723.12 |
| 900-36DS_B | 36"U | Call | Call | Call | Call | 1571.89 |

2-6" comes with (L) lever handle, 8-36" come with (B) bare stem



| Ordering Guide | |
|---------------------|----------|
| 900-02DS <u>E</u> L | E-EPDM |
| | B-BUNA-N |
| | P-PTFE |
| | V-Viton |

Butterfly Valve Handle

Gear Operator

Butterfly Gear Operator

Can be equipped to any butterfly valve.

| Part # | Size | List price | Carton | Weight |
|----------|----------|------------|--------|--------|
| BGO2-3 | 2", 3" | \$68.62 | 1 | 11.46 |
| BGO4 | 4" | \$68.86 | 1 | 11.46 |
| BGO5-6 | 5", 6" | \$68.86 | 1 | 11.46 |
| BGO8 | 8" | \$116.70 | 1 | 28.66 |
| BGO10 | 10" | \$116.70 | 1 | 28.66 |
| BGO12-14 | 12", 14" | \$149.90 | 1 | 33.07 |
| BGO16-20 | 16"- 20" | \$458.44 | 1 | 125.44 |
| BGO24 | 24" | \$714.52 | 1 | 159.55 |
| BGO30 | 30" | Call | 1 | 279.99 |
| BGO36 | 36" | Call | 1 | 348.33 |



GEAR OPERATOR

Carbon & Stainless Steel Ball Valves

T-SS-1001N

2 Piece • Full Port • 1000 WOG

- Solid ball construction
- Latch lock handle may be locked in open or closed position
- 29 in-HG vacuum rating
- 100% leak tested

Approvals 

| Part # | Size | List price | Carton | Weight |
|---------|--------|------------|--------|--------|
| 100-961 | 1/4" | \$26.41 | 10 | 7 |
| 100-962 | 3/8" | \$26.41 | 10 | 7 |
| 100-963 | 1/2" | \$29.61 | 10 | 8 |
| 100-964 | 3/4" | \$41.86 | 10 | 16 |
| 100-965 | 1" | \$58.62 | 8 | 18 |
| 100-966 | 1-1/4" | \$89.09 | 5 | 18 |
| 100-967 | 1-1/2" | \$117.92 | 5 | 26 |
| 100-968 | 2" | \$164.86 | 2 | 17 |



T-SS-1001N

T-CS-1001N-SS

2 Piece • Full Port • 1000 WOG • with Stainless Steel Trim

- Solid ball construction
- Latch lock handle may be locked in open or closed position
- 29 in-HG vacuum rating
- 100% leak tested

Approvals 

| Part # | Size | List price | Carton | Weight |
|---------|--------|------------|--------|--------|
| 100-971 | 1/4" | \$22.11 | 10 | 7 |
| 100-972 | 3/8" | \$22.11 | 10 | 7 |
| 100-973 | 1/2" | \$24.79 | 10 | 8 |
| 100-974 | 3/4" | \$36.01 | 10 | 16 |
| 100-975 | 1" | \$49.41 | 8 | 18 |
| 100-976 | 1-1/4" | \$74.16 | 5 | 18 |
| 100-977 | 1-1/2" | \$95.84 | 5 | 26 |
| 100-978 | 2" | \$137.69 | 2 | 17 |



T-CS-1001N-SS

T-SS-1001N-VB

2 Piece • Full Port • 1000 WOG • with Vented Ball

- Solid ball construction
- Latch lock handle may be locked in open or closed position
- AVS medium vacuum rating
- 100% leak tested

| Part # | Size | List price | Case | Carton | Weight |
|-----------|--------|------------|------|--------|--------|
| 100-961VB | 1/4" | \$21.67 | 84 | 14 | 49 |
| 100-962VB | 3/8" | \$21.54 | 84 | 14 | 49 |
| 100-963VB | 1/2" | \$24.86 | 72 | 12 | 61 |
| 100-964VB | 3/4" | \$34.34 | 54 | 9 | 64 |
| 100-965VB | 1" | \$49.70 | 24 | 4 | 49 |
| 100-966VB | 1-1/4" | \$77.11 | 12 | 2 | 57 |
| 100-967VB | 1-1/2" | \$115.52 | 12 | 2 | 48 |
| 100-968VB | 2" | \$163.84 | 8 | 2 | 49 |

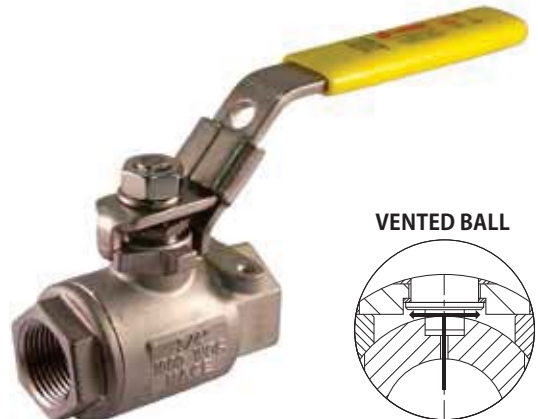

T-SS-1001N-VB

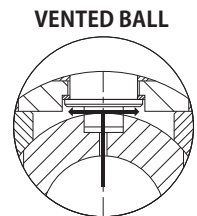

Carbon & Stainless Steel Ball Valves



T-SS-2000N

2 Piece • Standard Port • 2000 WOG

- Solid ball construction
- 29 in-HG vacuum rating
- Latch lock may be locked in open or closed position
- 100% leak tested

Approvals

| Part # | Size | List price | Carton | Weight |
|---------|--------|------------|--------|--------|
| 100-931 | 1/4" | \$25.29 | 10 | 6 |
| 100-932 | 3/8" | \$25.29 | 10 | 5 |
| 100-933 | 1/2" | \$27.02 | 10 | 7 |
| 100-934 | 3/4" | \$40.49 | 10 | 14 |
| 100-935 | 1" | \$51.05 | 10 | 19 |
| 100-936 | 1-1/4" | \$75.19 | 5 | 14 |
| 100-937 | 1-1/2" | \$102.53 | 5 | 20 |
| 100-938 | 2" | \$140.11 | 5 | 29 |



T-SS-2000N

T-CS-2000N-SS

2 Piece • Standard Port • 2000 WOG • with Stainless Steel Trim

- Solid ball construction
- Latch lock may be locked in open or closed position
- 29 in-HG vacuum rating
- 100% leak tested

Approvals

| Part # | Size | List price | Carton | Weight |
|---------|--------|------------|--------|--------|
| 100-951 | 1/4" | \$21.96 | 10 | 6 |
| 100-952 | 3/8" | \$21.96 | 10 | 5 |
| 100-953 | 1/2" | \$23.85 | 10 | 7 |
| 100-954 | 3/4" | \$34.85 | 10 | 14 |
| 100-955 | 1" | \$43.85 | 5 | 19 |
| 100-956 | 1-1/4" | \$63.53 | 5 | 14 |
| 100-957 | 1-1/2" | \$85.53 | 5 | 20 |
| 100-958 | 2" | \$117.69 | 5 | 29 |



T-CS-2000N-SS

T-CS-2000N-SS-VB

2 Piece • Standard Port • 2000 WOG • with Stainless Steel Trim and Vented Ball

- Solid ball construction
- Latch lock may be locked in open or closed position
- AVS medium vacuum rating
- 100% leak tested

| Part # | Size | List price | Case | Carton | Weight |
|-----------|--------|------------|------|--------|--------|
| 100-951VB | 1/4" | \$29.19 | 72 | 12 | 56 |
| 100-952VB | 3/8" | \$28.57 | 72 | 12 | 56 |
| 100-953VB | 1/2" | \$28.26 | 54 | 9 | 71 |
| 100-954VB | 3/4" | \$43.83 | 42 | 7 | 75 |
| 100-955VB | 1" | \$54.24 | 24 | 4 | 52 |
| 100-956VB | 1-1/4" | \$79.43 | 14 | 2 | 68 |
| 100-957VB | 1-1/2" | \$98.25 | 8 | 2 | 65 |
| 100-958VB | 2" | \$135.98 | 8 | 2 | 61 |



T-CS-2000N-SS-VB

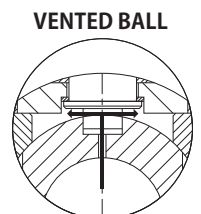

Carbon & Stainless Steel Ball Valves



NEW

T-SS-2000N-DH

2 Piece • Standard Port • 2000 WOG • with Spring Return Handle

- 1-1/4" - 2" 3 piece, 4 bolt pattern
- Solid ball construction
- 29 in-HG vacuum rating
- Latch lock may be locked in open or closed position
- 100% leak tested

Approvals

| Part # | Size | List price | Carton | Weight |
|-----------|--------|------------|--------|--------|
| 100-931DH | 1/4" | \$103.67 | 10 | 1.34 |
| 100-932DH | 3/8" | \$103.67 | 10 | 1.34 |
| 100-933DH | 1/2" | \$105.92 | 10 | 1.34 |
| 100-934DH | 3/4" | \$136.01 | 8 | 2.05 |
| 100-935DH | 1" | \$156.11 | 8 | 2.53 |
| 100-936DH | 1-1/4" | \$335.47 | - | - |
| 100-937DH | 1 1/2" | \$475.96 | - | - |
| 100-938DH | 2" | \$588.81 | - | - |



T-SS-2000N-DH

T-SS-1000N-4B & S-SS-1000N-4B

3 Piece 4 Bolt • Swing Out Body • Full Port • 1000 WOG

- Latch lock handle, may be locked in open or closed positions
- 29 in-HG vacuum rating
- Repair kit available
- 100% leak tested

Approvals

| Threaded | Socket | Size | List price | Carton | Weight |
|----------|---------|--------|------------|--------|--------|
| 500-301 | 500-341 | 1/4" | \$35.92 | 10 | 10 |
| 500-302 | 500-342 | 3/8" | \$35.92 | 10 | 10 |
| 500-303 | 500-343 | 1/2" | \$43.09 | 10 | 14 |
| 500-304 | 500-344 | 3/4" | \$56.56 | 10 | 21 |
| 500-305 | 500-345 | 1" | \$76.09 | 8 | 25 |
| 500-306 | 500-346 | 1-1/4" | \$118.96 | 5 | 24 |
| 500-307 | 500-347 | 1-1/2" | \$156.36 | 5 | 34 |
| 500-308 | 500-348 | 2" | \$229.53 | 2 | 21 |
| 500-310 | 500-350 | 3" | \$630.58 | 2 | 56 |
| 500-311 | 500-351 | 4" | \$1,034.08 | 1 | 45 |



T-SS-1000N-4B

S-SS-1000N-4B



T-SS-1000N-4B-VB

3 Piece 4 Bolt • Swing Out Body • Full Port • 1000 WOG

- Latch lock handle, may be locked in open or closed positions
- 29 in-HG vacuum rating
- Repair kit available
- AVS medium vacuum rating
- 100% leak tested

| Part # | Size | List price | Case | Carton | Weight |
|-----------|--------|------------|------|--------|--------|
| 500-301VB | 1/4" | \$25.70 | 72 | 12 | 48 |
| 500-302VB | 3/8" | \$27.43 | 72 | 12 | 48 |
| 500-303VB | 1/2" | \$32.05 | 60 | 10 | 68 |
| 500-304VB | 3/4" | \$44.04 | 36 | 6 | 65 |
| 500-305VB | 1" | \$60.94 | 12 | 2 | 48 |
| 500-306VB | 1-1/4" | \$91.27 | 12 | 2 | 60 |
| 500-307VB | 1-1/2" | \$141.82 | 8 | 2 | 55 |
| 500-308VB | 2" | \$204.78 | 8 | 2 | 48 |
| 500-310VB | 3" | \$562.20 | 2 | 1 | 45 |
| 500-311VB | 4" | \$1,099.38 | 1 | 1 | 45 |

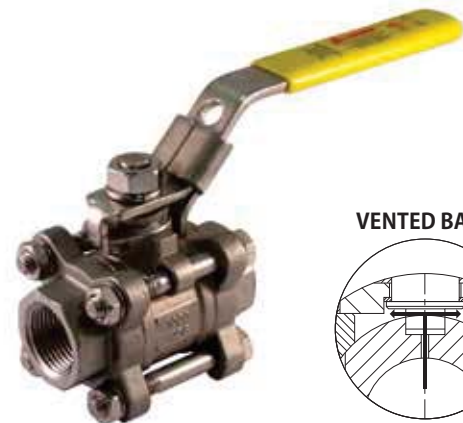

T-SS-1000N-4B-VB

VENTED BALL

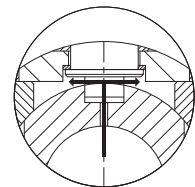

Carbon & Stainless Steel Ball Valves



T-CS-1000N-SS-4B & S-CS-1000N-SS-4B

3 Piece 4 Bolt • Swing Out Body • Full Port • 1000 WOG • with Stainless Steel Trim

- Latch lock handle, may be locked in open or closed positions
- 29 in-HG vacuum rating
- Repair parts available
- 100% leak tested

Approvals 

| Threaded | Socket | Size | List price | Carton | Weight |
|----------|---------|--------|------------|--------|--------|
| 500-401 | – | 1/4" | \$30.01 | 10 | 10 |
| 500-402 | – | 3/8" | \$30.01 | 10 | 10 |
| 500-403 | 500-503 | 1/2" | \$35.34 | 10 | 14 |
| 500-404 | 500-504 | 3/4" | \$46.91 | 10 | 21 |
| 500-405 | 500-505 | 1" | \$62.69 | 8 | 25 |
| 500-406 | 500-506 | 1-1/4" | \$95.69 | 5 | 24 |
| 500-407 | 500-507 | 1-1/2" | \$125.41 | 5 | 34 |
| 500-408 | 500-508 | 2" | \$183.52 | 2 | 21 |



T-CS-1000N-SS-4B

S-CS-1000N-SS-4B



T-CS-4000

Full Port • 7500 WOG

- Body pressure ratings:
 - 7500 PSI for 1/4" to 1/2"
 - 4800 PSI for 3/4" to 2"
- Temperature rating: 14°F to 176°F
- Safety factor: 2 to 1
- Delrin ball seats
- Viton stem seal
- NPT female thread to ANSI B1.20.1
- Lockable handle option
- Sizes 1/4" to 1" one block body design
- 1-1/4" to 2" are rounded body design
- 100% leak tested

| Part # | Size | List price | Carton | Weight |
|---------|--------|------------|--------|--------|
| 100-941 | 1/4" | \$46.88 | 20 | 0.46 |
| 100-942 | 3/8" | \$46.88 | 10 | 0.95 |
| 100-943 | 1/2" | \$49.64 | 10 | 1.48 |
| 100-944 | 3/4" | \$93.76 | 10 | 2.82 |
| 100-945 | 1" | \$118.58 | 10 | 4.34 |
| 100-946 | 1-1/4" | \$270.25 | – | 5.95 |
| 100-947 | 1 1/2" | \$336.44 | – | 7.28 |
| 100-948 | 2" | \$452.26 | – | 10.14 |



T-CS-4000

Carbon & Stainless Steel Ball Valves



T-SS-2001N-4B & S-SS-2001N-4B

3 Piece 4 Bolt Enclosed • Standard Port • 2000 WOG

- Latch lock handle
- Reversible handle for multiple applications
- Solid ball construction
- Blow out proof stem
- Latch lock handle may be locked in open or closed position
- ISO 5211 mounting pad for actuation
- 29 in-HG vacuum rating
- 100% leak tested
- Fire Safe

Approvals  T-SS-2001N-4B Only

| Threaded | Socket | Size | List price | Carton | Weight |
|----------|---------|--------|------------|--------|--------|
| 601-603 | 601-623 | 1/2" | \$64.70 | 10 | 19 |
| 601-604 | 601-624 | 3/4" | \$76.79 | 10 | 23 |
| 601-605 | 601-625 | 1" | \$121.10 | 8 | 31 |
| 601-606 | 601-626 | 1-1/4" | \$197.12 | 5 | 31 |
| 601-607 | 601-627 | 1-1/2" | \$208.81 | 5 | 39 |
| 601-608 | 601-628 | 2" | \$292.94 | 2 | 22 |



T-SS-2001N-4B

S-SS-2001N-4B



T-CS-2001N-SS-4B & S-CS-2001N-SS-4B

3 Piece 4 Bolt Enclosed • Standard Port • 2000 WOG • with Stainless Steel Trim

- Latch lock handle
- Reversible handle for multiple applications
- Solid ball construction
- Blow out proof stem
- Latch lock may be locked in open or closed position
- ISO 5211 mounting pad for actuation
- 29 in-HG vacuum rating
- Fire safe rated
- 100% leak tested

Approvals  T-CS-2001N-SS-4B Only

| Threaded | Socket | Size | List price | Carton | Weight |
|----------|---------|--------|------------|--------|--------|
| 601-613 | 601-633 | 1/2" | \$53.95 | 10 | 19 |
| 601-614 | 601-634 | 3/4" | \$66.18 | 10 | 23 |
| 601-615 | 601-635 | 1" | \$91.96 | 8 | 31 |
| 601-616 | 601-636 | 1-1/4" | \$154.96 | 5 | 31 |
| 601-617 | 601-637 | 1-1/2" | \$166.61 | 5 | 39 |
| 601-618 | 601-638 | 2" | \$241.06 | 2 | 22 |



T-CS-2001N-SS-4B

S-CS-2001N-SS-4B



Carbon & Stainless Steel Ball Valves



T-SS-2002N-DUE & S-SS-2002N-DUE

5 Piece • Full Port • Double Union End • 3000 WOG

- Solid ball construction
- 5 piece construction
- Mounting pad
- Reversible handle
- Adjustable stem packing with blow out proof stem
- 29 in-HG vacuum rating
- 100% leak tested

Approvals  UL LISTED T-SS-2002N-DUE Only

| Threaded | Socket | Size | List price | Carton | Weight |
|----------|---------|--------|------------|--------|--------|
| 100-981 | 101-981 | 1/4" | \$88.28 | 10 | 20 |
| 100-982 | 101-982 | 3/8" | \$88.28 | 10 | 19 |
| 100-983 | 101-983 | 1/2" | \$88.28 | 10 | 17 |
| 100-984 | 101-984 | 3/4" | \$115.81 | 8 | 20 |
| 100-985 | 101-985 | 1" | \$141.26 | 8 | 30 |
| 100-986 | 101-986 | 1-1/4" | \$222.61 | 6 | 34 |
| 100-987 | 101-987 | 1-1/2" | \$298.03 | 4 | 35 |
| 100-988 | 101-988 | 2" | \$410.92 | 2 | 26 |



T-SS-2002N-DUE

S-SS-2002N-DUE

T-CS-2002N-SS-DUE & S-CS-2002N-SS-DUE

5 Piece • Full Port • Double Union End • 3000 WOG • with Stainless Steel Trim

- Solid ball construction
- 5 piece construction
- Mounting pad
- Reversible handle
- Adjustable stem packing with blow out proof stem
- 29 in-HG vacuum rating
- 100% leak tested

Approvals  UL LISTED T-CS-2002N-SS-DUE Only

| Threaded | Socket | Size | List price | Carton | Weight |
|----------|---------|--------|------------|--------|--------|
| 100-991 | 101-991 | 1/4" | \$80.42 | 10 | 20 |
| 100-992 | 101-992 | 3/8" | \$80.42 | 10 | 19 |
| 100-993 | 101-993 | 1/2" | \$80.42 | 10 | 18 |
| 100-994 | 101-994 | 3/4" | \$101.85 | 8 | 21 |
| 100-995 | 101-995 | 1" | \$127.87 | 8 | 31 |
| 100-996 | 101-996 | 1-1/4" | \$193.64 | 6 | 35 |
| 100-997 | 101-997 | 1-1/2" | \$251.90 | 4 | 36 |
| 100-998 | 101-998 | 2" | \$348.60 | 2 | 26 |



T-CS-2002N-SS-DUE

S-CS-2002N-SS-DUE

T-SS-1000

1 Piece • Full Port • 1000 WOG

- Solid ball construction
- Corrosion resistant
- 29 in-HG vacuum rating
- 100% leak tested

| Part # | Size | List price | Carton | Weight |
|---------|---------------------|------------|--------|--------|
| 500-098 | 1/8" FIP x 1/8" MIP | \$44.54 | 10 | 2 |
| 500-099 | 1/4" FIP x 1/4" MIP | \$50.68 | 10 | 4 |
| 500-100 | 1/4" FIP x 1/4" FIP | \$34.60 | 10 | 2 |
| 500-101 | 1/4" FIP x 1/4" FIP | \$35.84 | 10 | 2 |
| 500-102 | 3/8" FIP x 3/8" FIP | \$29.42 | 10 | 2 |



500-098

500-099

500-100

500-101

500-102

T-SS-1000

Stainless Steel Flanged Ball Valves



FL-SS-100-150

2 Piece • Full Port • Flanged Connection • Class 150

- Wrench operator
- Fire safe stem and body graphite seals
- Air tested seat leakage: 85 PSI
- Hydraulic tested body: 427 PSI
- Locking device comes standard
- 100% leak tested

Approvals  

| Part # | Size | List price | Carton | Weight |
|----------|--------|-------------|--------|--------|
| 600-103 | 1/2" | \$119.06 | 2 | 8 |
| 600-104 | 3/4" | \$131.13 | 2 | 10 |
| 600-105 | 1" | \$183.23 | 2 | 14 |
| 600-107 | 1-1/2" | \$337.61 | 2 | 27 |
| 600-108 | 2" | \$474.16 | 1 | 22 |
| 600-109 | 2-1/2" | \$692.18 | 1 | 35 |
| 600-110 | 3" | \$1,013.35 | 1 | 48 |
| 600-111 | 4" | \$1,676.51 | 1 | 75 |
| 600-112 | 6" | \$4,976.72 | 1 | 68 |
| 600-113* | 8" | \$8,758.61 | 1 | 305 |
| 600-114* | 10" | \$15,313.24 | 1 | 475 |
| 600-115* | 12" | \$23,805.40 | 1 | 817 |

*Special order



FL-SS-100-150

FL-SS-100-300

2 Piece • Full Port • Flanged Connection • Class 300

- Wrench operator
- Fire safe stem and body graphite seals
- Air tested seat leakage: 85 PSI
- Hydraulic tested body: 1124 PSI
- Locking device comes standard
- 100% leak tested

Approvals  

| Part # | Size | List price | Carton | Weight |
|----------|------|------------|--------|--------|
| 600-128 | 2" | \$661.93 | 1 | 22 |
| 600-130 | 3" | \$1,163.19 | 1 | 48 |
| 600-131 | 4" | \$2,316.58 | 1 | 75 |
| 600-132 | 6" | \$5,850.73 | 1 | 68 |
| 600-133* | 8" | \$9,163.54 | 1 | 305 |

*Special order



FL-SS-100-300

Carbon Steel Flanged Ball Valves



FL-CS-100-150

2 Piece • Full Port • Flanged Connections • Class 150 • with Stainless Steel Trim

- Wrench operator
- Fire safe stem and body graphite seals
- Air tested seat leakage: 85 PSI
- Hydraulic tested body: 427 PSI
- Conforms to ANSI B16.34
- Locking device comes standard
- 100% leak tested

Approvals  

| Part # | Size | List price | Carton | Weight |
|----------|--------|-------------|--------|--------|
| 600-203 | 1/2" | \$91.86 | 2 | 8 |
| 600-204 | 3/4" | \$103.15 | 2 | 10 |
| 600-205 | 1" | \$130.78 | 2 | 14 |
| 600-207 | 1-1/2" | \$223.62 | 2 | 27 |
| 600-208 | 2" | \$293.55 | 1 | 22 |
| 600-209 | 2-1/2" | \$416.46 | 1 | 35 |
| 600-210 | 3" | \$631.51 | 1 | 48 |
| 600-211 | 4" | \$961.95 | 1 | 75 |
| 600-212 | 6" | \$1,962.72 | 1 | 168 |
| 600-213* | 8" | \$4,316.54 | 1 | 305 |
| 600-214* | 10" | \$8,761.76 | 1 | 475 |
| 600-215* | 12" | \$13,582.01 | 1 | 817 |

*Special order



FL-CS-100-150

FL-CS-100-300

2 Piece • Full Port • Flanged Connection • Class 300 • with Stainless Steel Trim

- Wrench operator
- Fire safe stem and body graphite seals
- Air tested seat leakage: 85 PSI
- Hydraulic tested body: 1124 PSI
- Locking device comes standard
- 100% leak tested

Approvals 

| Part # | Size | List price | Carton | Weight |
|----------|------|------------|--------|--------|
| 600-228 | 2" | \$386.91 | 1 | 22 |
| 600-230 | 3" | \$794.46 | 1 | 48 |
| 600-231 | 4" | \$1,317.92 | 1 | 75 |
| 600-232 | 6" | \$2,360.64 | 1 | 168 |
| 600-233* | 8" | \$4,820.42 | 1 | 305 |

*Special order



FL-CS-100-300

Electric Actuators



AE Series Actuators

Double Acting • Nema 4x • Manual Override

- Hard anodized aluminum housing with external powder coating for severe duty applications
- 90° operation
- Enclosure: IP67 (Nema 4, 4X)
- ISO 5211 mounting
- Worm gearing, no brake required
- Manual override standard
- Torque switches for overload protection (except for AE450 and AE700)
- Squirrel cage induction motor
- Duty Cycle: AE450 is 30%, for all others 50%
- 4 Limit switches (2 for AE450)
- Cable entries: 1/2" NPT for AE450 - 3/4" NPT for all others
- 5W internal heater (except for AE450 and AE700)
- Terminal block for ease in wiring
- Position indicator
- Adjustable travel stops standard
- Temperature range: -4°F to 158°F - AE700 and larger -22°F to 140°F - AE450



AE-180



AE-450



AE-700



AE-880



AE-1400



AE-700M



AE-880M

| Part # | Torque | Voltage | Cycle | List Price |
|---------------|--------|---------|-------|------------|
| ON/OFF | | | | |
| AE-180 | 180 | 120 | 12 | \$300.32 |
| AE-450 | 450 | 120 | 18 | \$515.74 |
| AE-700 | 700 | 120 | 14 | \$509.50 |
| AE-880 | 880 | 120 | 21 | \$802.50 |
| AE-1400 | 1400 | 120 | 26 | \$972.28 |
| AE-2100 | 2125 | 120 | 26 | \$1,039.52 |
| AE-3100 | 3098 | 120 | 31 | \$1,150.00 |
| AE-4400 | 4425 | 120 | 31 | \$1,350.00 |
| AE-7000 | 7080 | 120 | 39 | \$1,650.00 |
| AE-9700 | 9735 | 120 | 39 | \$1,800.00 |

Modulating

| | | | | |
|----------|------|-----|----|------------|
| AE-700M | 700 | 120 | 14 | \$1,327.62 |
| AE-880M | 880 | 120 | 21 | \$1,697.30 |
| AE-1400M | 1400 | 120 | 26 | \$1,702.00 |
| AE-2100M | 2125 | 120 | 26 | \$1,787.00 |
| AE-3100M | 3098 | 120 | 31 | \$1,855.00 |
| AE-4400M | 4425 | 120 | 31 | \$1,995.00 |
| AE-7000M | 7080 | 120 | 39 | \$2,300.00 |
| AE-9700M | 9735 | 120 | 39 | \$2,450.00 |

Specialty Electronic Actuators



In addition to the AE Series, Jomar Valve also offers a wide range of specialty electric actuators tailored for your specific application. As a proud provider of Indelac Controls, Jomar Valve offers you the following Made in America products:

- NEMA 4, 4x & 7 Enclosures
- Spring Return Electric Actuators
- 24, 115, 230, & 480 AC/ DC Voltages
- 100lbs-14000lbs Torque ranges
- Other Actuator Accessories

Jomar Valve can accommodate any application, please contact our inside sales team at 800-325- 5690 for assistance.

Pneumatic Actuators



Alpha Series Actuators

Spring Return • Double Acting Rotary

The Jomar Alpha Series rotary pneumatic actuators are designed for use with quarter-turn ball, butterfly and plug valves as well as damper applications. The Alpha Series actuator incorporates the latest technology in design and engineering. It is designed for high-cycle applications and can be utilized in hazardous and corrosive environments.



ALPHA SERIES

| AD Double Acting | List price | AS Spring Return | List price |
|------------------|-------------|------------------|------------|
| AD-50 | \$213.68 | AS-50-12 | \$243.57 |
| AD-60 | \$259.02 | AS-60-12 | \$309.17 |
| AD-70 | \$339.69 | AS-70-12 | \$347.78 |
| AD-80 | \$364.30 | AS-80-12 | \$392.31 |
| AD-90 | \$432.15 | AS-90-12 | \$486.96 |
| AD-100 | \$464.08 | AS-100-12 | \$555.62 |
| AD-120 | \$553.30 | AS-120-12 | \$655.79 |
| AD-140 | \$727.06 | AS-140-12 | \$977.27 |
| AD-160 | \$1,123.88 | AS-160-12 | \$1,367.24 |
| AD-190 | \$1,408.87 | AS-190-12 | \$1,845.08 |
| AD-200 | \$1,886.32 | AS-200-12 | \$2,052.27 |
| AD-240 | \$2,538.61 | AS-240-12 | \$3,550.80 |
| AD-270 | \$3,500.62 | AS-270-12 | \$3,759.78 |
| AD-300 | \$3,900.69 | AS-300-12 | \$5,129.23 |
| AD-350 | \$7,000.00 | AS-350-12 | \$9,650.68 |
| AD-400 | \$11,500.25 | | |

O-ring Repair Kits

| Viton® Repair Kits | List price | EPDM Repair Kits | List price |
|--------------------|------------|------------------|------------|
| ARK-30V | \$40.90 | ARK-30E | \$9.82 |
| ARK-40V | \$45.81 | ARK-40E | \$10.80 |
| ARK-50V | \$33.54 | ARK-50E | \$41.30 |
| ARK-60V | \$40.07 | ARK-60E | \$53.02 |
| ARK-70V | \$45.68 | ARK-70E | \$55.04 |
| ARK-80V | \$53.54 | ARK-80E | \$68.96 |
| ARK-90V | \$61.65 | ARK-90E | \$73.59 |
| ARK-100V | \$81.48 | ARK-100E | \$80.12 |
| ARK-120V | \$111.12 | ARK-120E | \$101.76 |
| ARK-140V | \$151.81 | ARK-140E | \$122.65 |
| ARK-160V | \$162.12 | ARK-160E | \$163.57 |
| ARK-190V | \$191.77 | ARK-190E | \$229.77 |
| ARK-200V | \$214.83 | ARK-200E | \$258.48 |
| ARK-240V | \$246.66 | ARK-240E | \$296.76 |
| ARK-270V | \$285.20 | ARK-270E | \$336.46 |
| ARK-300V | \$378.47 | | |
| ARK-350V | \$462.60 | | |
| ARK-400V | \$509.04 | | |

Adapters

| ARA Adapters | List Price | ASQ Adapters | List Price |
|--------------|------------|--------------|------------|
| ARA-4335 | \$18.00 | ASQ-4335 | \$18.00 |
| ARA-5535 | \$18.00 | ASQ-5543 | \$18.00 |
| ARA-5543 | \$18.00 | ASQ-6743 | \$18.00 |
| ARA-6743 | \$18.00 | ASQ-6755 | \$18.00 |
| ARA-6755 | \$18.00 | ASQ-8667 | \$18.00 |
| ARA-7543 | \$18.00 | | |
| ARA-7555 | \$18.00 | | |
| ARA-7567 | \$18.00 | | |
| ARA-8767 | \$18.00 | | |
| ARA-8775 | \$18.00 | | |
| ARA-10667 | \$20.00 | | |
| ARA-10687 | \$20.00 | | |
| ARA-14287 | \$20.00 | | |

Positioners

EP-100

Electro-Pneumatic Rotary Positioner

- Aluminum housing construction
- Visual position indicator
- Enclosure: IP66
- Input: 4-20mA / 0-10 VDC
- Supply: 20-100 PSI
- Impedance: 250 OHM \pm 15 OHM
- Linearity: \pm 1% / \pm 2% FS
- Operating Temperature: -4°F to 158°F
- Repeatability: \pm .5% FS
- Hysteresis: \pm 1% FS
- Flow Capacity: 80 LPM
- Air Consumption: 3 LPM
- Weight: 6.5 LB
- Explosion proof approval: Exdm IIBT5
- Signal: 1/2" conduit
- Connections: 1/4" air / 1/8" gauge
- For use with 1/4-turn rotary actuators



EP-100

| Part # | Description | List price |
|-----------|---|------------|
| AEP-100 | Electro-Pneumatic | \$945.74 |
| AEP-100LS | Electro-Pneumatic w/ Limit Switch | \$1,148.31 |
| AEP-100TM | Electro-Pneumatic w/ 4-20mA Transmitter | \$1,461.57 |

PP-200

Pneumatic Rotary Positioner

- Aluminum housing construction
- Visual position indicator
- Input: 3-15 PSI
- Supply: 20-100 PSI
- Linearity: \pm 2% FS
- Operating Temperature: -20°F to 185°F
- Repeatability: \pm .5% FS
- Hysteresis: \pm 1% FS
- Flow Capacity: 80 LPM
- Air Consumption: 3 LPM
- Weight: 4 LB
- Enclosure: IP66
- Connections: 1/4" air / 1/8" gauge
- For use with 1/4-turn rotary actuators



PP-200

| Part # | Description | List price |
|---------|-------------|------------|
| APP-200 | Pneumatic | \$482.24 |

Solenoid Valves & Limit Switches



SV-120

Four Way Solenoid Valve

- Extruded aluminum body with NBR seal
- 120/60/1 coil with IP 67 rating
- Manual override
- 1/4" NPT Exhaust port
- 1/2" NPT conduit connection
- Operating Temp: -40°F to 140°F
- Operating Pressure: 20 to 120 PSI



SV-120

| Part # | Description | List price |
|-----------------|------------------------------|------------|
| ASV-120 | 120VAC Solenoid Valve, Namur | \$66.00 |
| ASV-120XP | Exp. Proof, 120VAC | \$169.69 |
| ASC-24VDC Coil | Coil Only | \$10.00 |
| ASC-24VAC Coil | Coil Only | \$10.00 |
| ASC-240VDC Coil | Coil Only | \$10.00 |
| ASCM-28 | 1/4" Speed Control | \$10.00 |
| ABV-28 | 1/4" Breather Vent | \$10.00 |

SM-200

Limit Switch with Dome Indicator

- Die-cast aluminum, epoxy-polyester coated housing
- O-ring sealed to prevent contaminants from entering switch compartment
- Position indicator manufactured of high-impact polycarbonate; yellow = open / red = closed
- Mechanical switches (2) are of SPDT design
- Eight position terminal strip included
- Enclosure is IP 67 weatherproof design
- Stainless steel mounting bracket made to NAMUR



SM-200

| Part # | Description | List price |
|-----------|------------------------------|------------|
| ASM-200 | Limit Switch, 2 SPDT | \$90.19 |
| ASM-400 | Limit Switch, 4 SPDT | \$111.07 |
| ASP-210 | Limit Switch, 2 Proximity | \$206.07 |
| ASM-X-200 | Explosion Proof, Eexd IIB T6 | \$162.75 |
| ASP-X-210 | Explosion Proof, Eexd IIB T6 | \$310.30 |
| ASM-SS1 | 30x80x20(H)mm Standard | \$21.62 |
| ASM-SS2 | 30x80x30(H)mm | \$21.62 |
| ASM-SS3 | 30x80x130(H)mm | \$27.79 |

Direct Mount

A2020D

**2 Piece • Full Port • Flanged Connection • Class 150
with ISO Mounting Pad**

- Vented ball for safety precautions
- ISO 5211 / DIN 3337 direct mounting pad
- Blow-out proof stem
- ANSI B16.34 and B16.35, Class 150
- Carbon stainless available upon request
- AVS high vacuum rating
- 100% tested

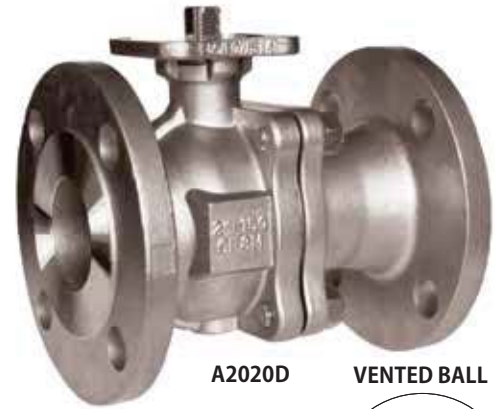

A2020D

VENTED BALL

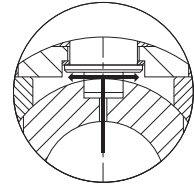

| Part # | Size | List price |
|------------|--------|------------|
| A2020D-12 | 1/2" | \$111.38 |
| A2020D-34 | 3/4" | \$129.12 |
| A2020D-1 | 1" | \$179.84 |
| A2020D-114 | 1-1/4" | \$292.23 |
| A2020D-112 | 1-1/2" | \$382.49 |
| A2020D-2 | 2" | \$483.82 |
| A2020D-212 | 2-1/2" | \$855.20 |
| A2020D-3 | 3" | \$914.87 |
| A2020D-4 | 4" | \$1,458.31 |

A9000TD

**3 Piece 4 Bolt • Standard Port • Clamp Connection • 1000 WOG
with ISO Mounting Pad**

- 3-Piece design for ease of maintenance
- 316SS body, ball and stem
- 20RA I.D. finish
- FDA approved PTFE cavity filler seats, RPTFE stem seal, Viton® stem O-ring, and V-ring stem packing
- 304 SS bolts, nuts and washers
- ISO 5211 mounting pad
- Square stem design for direct mounting
- CE stamped



A9000TD

| Part # | Size | List price |
|-------------|--------|------------|
| A9000TD-12 | 1/2" | \$181.69 |
| A9000TD-34 | 3/4" | \$219.48 |
| A9000TD-1 | 1" | \$266.57 |
| A9000TD-112 | 1-1/2" | \$489.67 |
| A9000TD-2 | 2" | \$627.47 |
| A9000TD-212 | 2-1/2" | \$1,265.06 |
| A9000TD-3 | 3" | \$1,855.04 |
| A9000TD-4 | 4" | \$2,584.15 |

Weld End also available (9000 TDW)

Direct Mount

A1000

**3 Piece 4 Bolt • Full Port • Threaded Connection • 1000 WOG
with ISO Mounting Pad**

- ISO 5211 mounting pad
- 3-piece swing out body

| Part # | Size | List price |
|-----------|--------|------------|
| A1000-14 | 1/4" | \$95.54 |
| A1000-38 | 3/8" | \$95.54 |
| A1000-12 | 1/2" | \$97.31 |
| A1000-34 | 3/4" | \$102.90 |
| A1000-1 | 1" | \$156.39 |
| A1000-114 | 1-1/4" | \$199.10 |
| A1000-112 | 1-1/2" | \$249.17 |
| A1000-2 | 2" | \$415.09 |
| A1000-212 | 2-1/2" | \$742.76 |
| A1000-3 | 3" | \$1,102.46 |
| A1000-4 | 4" | \$1,593.53 |



A1000

A-750T & A-750L

**3-Way • Standard Port • Threaded Connection • 400 WOG
with ISO Mounting Pad**

- ISO 5211 direct mounting pad
- Square valve stem for direct mounting to any ISO actuator
- Four seats standard
- Temperatures to 344°F
- Blow-out proof stem

| T-Port | L-Port | Size | List Price |
|-----------|-----------|--------|------------|
| A750T-14 | A750L-14 | 1/4" | \$78.50 |
| A750T-38 | A750L-38 | 3/8" | \$78.50 |
| A750T-12 | A750L-12 | 1/2" | \$78.50 |
| A750T-34 | A750L-34 | 3/4" | \$88.60 |
| A750T-1 | A750L-1 | 1" | \$137.74 |
| A750T-114 | A750L-114 | 1-1/4" | \$191.91 |
| A750T-112 | A750L-112 | 1-1/2" | \$300.70 |
| A750T-2 | A750L-2 | 2" | \$489.07 |
| A750T-212 | A750L-212 | 2-1/2" | \$875.40 |
| A750T-3 | A750L-3 | 3" | \$931.92 |



A-750TL

A9500

Sanitary Butterfly Valve

- 360° installation - valve may be installed in any position
- Self draining
- Wetted surfaces have sanitary finish
- USDA approved

| Part # | Size | List price |
|------------|--------|------------|
| A9500C-1 | 1" | \$335.33 |
| A9500C-112 | 1-1/2" | \$342.95 |
| A9500C-2 | 2" | \$365.81 |
| A9500C-212 | 2-1/2" | \$396.30 |
| A9500C-3 | 3" | \$535.09 |
| A9500C-4 | 4" | \$731.62 |
| A9500C-6 | 6" | \$1,400.00 |



A9500

Direct Mount



A-850TL

**3-Way • Full or Standard Port • Threaded Connection
1000 WOG • with ISO Mounting Pad**

- Self adjusting stem packing
- Blow-out proof stem design
- 100% tested
- Temperature range: -20° F to 450° F
- ISO 5211 mounting pad

| T-Port | L-Port | Size | List Price |
|-----------|-----------|--------|------------|
| A850T-14 | A850L-14 | 1/4" | \$175.00 |
| A850T-38 | A850L-38 | 3/8" | \$175.00 |
| A850T-12 | A850L-12 | 1/2" | \$211.50 |
| A850T-34 | A850L-34 | 3/4" | \$284.71 |
| A850T-1 | A850L-1 | 1" | \$366.05 |
| A850T-114 | A850L-114 | 1-1/4" | \$517.35 |
| A850T-112 | A850L-112 | 1-1/2" | \$691.43 |
| A850T-2 | A850L-2 | 2" | \$1,163.91 |



A-850TL

A-766L

Reduced Port • 3-Way Flanged Connection • Class 150

- Compact design
- AISI 316 stainless steel
- ANSI 150 flanged
- Max Temp 344° F
- Blow out proof stem
- 100% tested
- L port style
- T-port available upon request
- Contact Jomar Valve for material specs

| Part # | Size | List price |
|-----------|--------|------------|
| A766L-12 | 1/2" | \$831.19 |
| A766L-34 | 3/4" | \$846.18 |
| A766L-1 | 1" | \$926.17 |
| A766L-114 | 1-1/4" | \$1,318.66 |
| A766L-112 | 1-1/2" | \$1,536.17 |
| A766L-2 | 2" | \$1,799.86 |
| A766L-212 | 2-1/2" | \$3,147.23 |
| A766L-3 | 3" | \$4,175.90 |
| A766L-4 | 4" | \$6,421.98 |



A-766L

Mounting Brackets

ISO Mounting Pad for Electric and Pneumatic Actuators

| Bracket | Coupler | Size | List Price |
|------------|------------|-------------|------------|
| A1B | A1C11 | 1/4 - 1/2" | \$70.00 |
| A2B | A2C11 | 3/4" | \$70.00 |
| A3B | A3C11 | 1", 1-1/4" | \$70.00 |
| A4B | A4C11 | 1-1/2" | \$70.00 |
| A4B | A4C11 | 2" | \$70.00 |
| Fabricated | Fabricated | 2-1/2" - 4" | Call |

A reducing adapter may also be required.



T-100NE

T-100SSE

MOUNTING BRACKETS
(Shown mounted)

Low Pressure Valves

T-511 & S-511

300 WOG

- Constructed of 85-5-5-5 bronze
- Vertical or horizontal positions

| Threaded | Solder | Size | List price | Case | Carton | Weight |
|----------|---------|--------|------------|------|--------|--------|
| 105-303 | 105-403 | 1/2" | \$33.36 | 60 | 10 | 62 |
| 105-304 | 105-404 | 3/4" | \$45.49 | 40 | 10 | 69 |
| 105-305 | 105-405 | 1" | \$70.98 | 30 | 10 | 86 |
| 105-306 | 105-406 | 1-1/4" | \$93.85 | 20 | 5 | 59 |
| 105-307 | 105-407 | 1-1/2" | \$139.59 | 16 | 4 | 77 |
| 105-308 | 105-408 | 2" | \$192.22 | 8 | 2 | 87 |
| 105-309 | 105-409 | 2-1/2" | \$339.43 | 6 | 1 | 69 |
| 105-310 | 105-410 | 3" | \$450.90 | 4 | 1 | 72 |



T-511

S-511

T-501 & S-501

200 WOG

- Residential and commercial applications

| Threaded | Solder | Size | List price | Case | Carton | Weight |
|----------|---------|--------|------------|------|--------|--------|
| 105-103 | 105-203 | 1/2" | \$8.46 | 160 | 10 | 76 |
| 105-104 | 105-204 | 3/4" | \$11.02 | 120 | 10 | 78 |
| 105-105 | 105-205 | 1" | \$14.81 | 72 | 6 | 74 |
| 105-106 | 105-206 | 1-1/4" | \$24.95 | 60 | 5 | 89 |
| 105-107 | 105-207 | 1-1/2" | \$31.59 | 32 | 4 | 63 |
| 105-108 | 105-208 | 2" | \$50.01 | 24 | 2 | 70 |
| 105-109 | – | 2-1/2" | \$86.90 | 12 | 2 | 72 |
| 105-110 | – | 3" | \$126.49 | 6 | 1 | 52 |
| 105-111 | – | 4" | \$193.87 | 4 | 1 | 57 |



T-501

S-501

T-301 & S-301

Non-rising Stem • 200 WOG

- Manufactured in ISO-9001 facility
- ANSI B16.20.1 threaded ends
- Solid wedge gate

Approvals

| Threaded | Solder | Size | List price | Case | Carton | Weight |
|----------|---------|--------|------------|------|--------|--------|
| 103-301 | – | 1/4" | \$7.67 | 120 | 10 | 70 |
| 103-302 | – | 3/8" | \$7.67 | 120 | 10 | 68 |
| 103-303 | 103-403 | 1/2" | \$7.67 | 120 | 10 | 72 |
| 103-304 | 103-404 | 3/4" | \$10.42 | 90 | 10 | 77 |
| 103-305 | 103-405 | 1" | \$15.60 | 60 | 5 | 72 |
| 103-306 | 103-406 | 1-1/4" | \$22.02 | 40 | 5 | 74 |
| 103-307 | 103-407 | 1-1/2" | \$28.00 | 32 | 4 | 72 |
| 103-308 | 103-408 | 2" | \$42.18 | 20 | 2 | 68 |
| 103-309 | 103-409 | 2-1/2" | \$79.54 | 12 | 2 | 88 |
| 103-310 | 103-410 | 3" | \$108.13 | 8 | 1 | 81 |
| 103-311 | – | 4" | \$167.27 | 4 | 1 | 72 |



T-301

S-301

Low Pressure Valves

T-302

Non-rising Stem • Compression Connection • 200 WOG

- Manufactured in ISO-9001 facility
- Solid wedge gate

Approvals

| Part # | Size | List price | Case | Carton | Weight |
|---------|------|------------|------|--------|--------|
| 103-423 | 1/2" | \$10.02 | 120 | 10 | 97 |
| 103-424 | 3/4" | \$13.62 | 90 | 10 | 92 |
| 103-425 | 1" | \$20.47 | 60 | 5 | 88 |



T-302

T-612

Compression Connection • 200 WOG

- Manufactured in ISO-9001 facility

Approvals

| Part # | Size | List price | Case | Carton | Weight |
|---------|------|------------|------|--------|--------|
| 200-313 | 1/2" | \$8.78 | 100 | 10 | 55 |
| 200-314 | 3/4" | \$12.12 | 100 | 10 | 70 |



T-612

T-601 & S-601

200 WOG

- Manufactured in ISO-9001 facility

Approvals

| Threaded | Size | List price | Case | Carton | Weight |
|----------|------|------------|------|--------|--------|
| 200-003 | 1/2" | \$6.54 | 100 | 10 | 59 |
| 200-004 | 3/4" | \$7.22 | 100 | 10 | 64 |

| Solder | Size | List price | Case | Carton | Weight |
|---------|------|------------|------|--------|--------|
| 200-103 | 1/2" | \$5.75 | 100 | 10 | 53 |
| 200-104 | 3/4" | \$6.71 | 100 | 10 | 60 |



T-601



S-601

Low Pressure Valves

T-611 & S-611

Threaded Connection • 200 WOG

• Manufactured in ISO-9001 facility

Approvals

| Threaded | Size | List price | Case | Carton | Weight |
|----------|------|------------|------|--------|--------|
| 200-203 | 1/2" | \$6.82 | 100 | 10 | 60 |
| 200-204 | 3/4" | \$7.50 | 100 | 10 | 66 |

| Solder | Size | List price | Case | Carton | Weight |
|---------|------|------------|------|--------|--------|
| 200-303 | 1/2" | \$6.03 | 100 | 10 | 52 |
| 200-304 | 3/4" | \$6.99 | 100 | 10 | 62 |



T-611

S-611

T-621 & T-622

125 WOG

• Manufactured in ISO-9001 facility

Approvals

| Male | Size | List price | Case | Carton | Weight |
|---------|------|------------|------|--------|--------|
| 201-003 | 1/2" | \$6.17 | 100 | 10 | 53 |
| 201-004 | 3/4" | \$6.37 | 100 | 10 | 57 |

| Female | Size | List price | Case | Carton | Weight |
|---------|------|------------|------|--------|--------|
| 201-103 | 1/2" | \$5.97 | 100 | 10 | 46 |
| 201-104 | 3/4" | \$6.45 | 100 | 10 | 51 |



T-621

T-622

T-641 & S-641

125 WOG

• Manufactured in ISO-9001 facility

• 3/4" hose thread outlet

Approvals

| Threaded | Size | List price | Case | Carton | Weight |
|----------|------|------------|------|--------|--------|
| 202-003 | 1/2" | \$6.31 | 100 | 10 | 58 |
| 202-004 | 3/4" | \$6.82 | 100 | 10 | 64 |

| Solder | Size | List price | Case | Carton | Weight |
|---------|------|------------|------|--------|--------|
| 202-103 | 1/2" | \$6.99 | 100 | 10 | 59 |
| 202-104 | 3/4" | \$6.65 | 100 | 10 | 65 |



T-641

S-641

Low Pressure Valves



T-653 & T-654

Vacuum Breakers

- 3/4" hose connection
- Tamper-resistant breakaway screw
- Heavy brass construction
- POM internal components

| T-653 - Brass | Size | List price | Case | Carton | Weight |
|---------------|------|------------|------|--------|--------|
| 203-204 | 3/4" | \$7.13 | 240 | 20 | 51 |

| T-654 - Chrome Plated | Size | List price | Case | Carton | Weight |
|-----------------------|------|------------|------|--------|--------|
| 203-205 | 3/4" | \$7.59 | 240 | 20 | 51 |



T-653



T-654

T-540

Half-Turn Frost Free Sillcock with Integral Vacuum Breaker

- Integral vacuum breaker
- Chrome plated brass vacuum breaker cap
- 3/4" hose outlet

Approvals

| MIP | Size | List price | Case | Carton | Weight |
|---------|------------|------------|------|--------|--------|
| 202-202 | 1/2" x 6" | \$41.64 | 20 | 1 | 35 |
| 202-203 | 1/2" x 8" | \$42.92 | 20 | 1 | 37 |
| 202-204 | 1/2" x 10" | \$43.99 | 20 | 1 | 38 |
| 202-205 | 1/2" x 12" | \$45.24 | 20 | 1 | 39 |
| 202-206 | 1/2" x 14" | \$46.49 | 20 | 1 | 41 |

1/2" has 1/2" copper solder inside

| MIP | Size | List price | Case | Carton | Weight |
|---------|------------|------------|------|--------|--------|
| 202-209 | 3/4" x 8" | \$43.99 | 20 | 1 | 37 |
| 202-210 | 3/4" x 10" | \$45.24 | 20 | 1 | 38 |
| 202-211 | 3/4" x 12" | \$46.49 | 20 | 1 | 39 |

3/4" has 1/2" FIP inside

| Pex | Size | List price | Case | Carton | Weight |
|-----------|------------|------------|------|--------|--------|
| 202-202PE | 1/2" x 6" | \$41.64 | 20 | 1 | 35 |
| 202-203PE | 1/2" x 8" | \$42.92 | 20 | 1 | 37 |
| 202-204PE | 1/2" x 10" | \$43.99 | 20 | 1 | 38 |
| 202-205PE | 1/2" x 12" | \$45.24 | 20 | 1 | 39 |



T-540

T-632 & T-632 (NK)

Nickel Plated • Quarter Turn 200 WOG

- Lockable handle open/close position
- Aluminum T-handle for easy operation
- Long life positive shutoff
- Nickel-plated finish
- 1/2" T-632 has combination 1/2" M.I.P and 1/2" solder inlet

| Part # | No Kink | Size | List price | Case | Carton | Weight |
|---------|---------|------|------------|------|--------|--------|
| 201-205 | 201-207 | 1/2" | \$8.07 | 100 | 10 | 42 |
| 201-206 | 201-208 | 3/4" | \$8.66 | 100 | 10 | 55 |



T-632



T-632 (NK)

Thermoplastics/CPVC & PVC Valves



S-605

CPVC • 150 WOG

- Copper Tube Size (CTS) connections
- For hot/cold water systems
- Quarter-turn operation
- Large port
- Easy installation

Approvals

| Part # | Size | List price | Case | Carton | Weight |
|---------|--------|------------|------|--------|--------|
| 210-603 | 1/2" | \$4.60 | 100 | 10 | 13 |
| 210-604 | 3/4" | \$5.48 | 100 | 5 | 22 |
| 210-605 | 1" | \$7.86 | 100 | 1 | 39 |
| 210-606 | 1-1/4" | \$9.92 | 100 | 1 | 59 |
| 210-607 | 1-1/2" | \$12.62 | 48 | 1 | 59 |
| 210-608 | 2" | \$20.35 | 48 | 1 | 62 |



S-605

T-701 & S-701

PVC • Schedule 80 • 150 WOG

- NPS connections
- Each valve tested in open and closed position
- Minimal pressure drop/turbulence
- Large ports for greater flow
- Corrosion resistant PVC material

Approvals

| Threaded | Solder | Size | List price | Case | Carton | Weight |
|----------|---------|--------|------------|------|--------|--------|
| 210-203 | 210-223 | 1/2" | \$2.73 | 100 | 1 | 20 |
| 210-204 | 210-224 | 3/4" | \$3.52 | 100 | 1 | 32 |
| 210-205 | 210-225 | 1" | \$4.50 | 100 | 1 | 50 |
| 210-206 | 210-226 | 1-1/4" | \$5.52 | 100 | 1 | 66 |
| 210-207 | 210-227 | 1-1/2" | \$9.16 | 48 | 1 | 66 |
| 210-208 | 210-228 | 2" | \$12.05 | 24 | 1 | 40 |
| 210-209 | 210-229 | 2-1/2" | \$24.13 | 12 | 1 | 40 |
| 210-210 | 210-230 | 3" | \$39.12 | 12 | 1 | 56 |
| 210-211 | 210-231 | 4" | \$74.25 | 6 | 1 | 57 |



T-701



S-701

T/S-703

Tru-Union PVC • Schedule 80 • 150 WOG

• NPS connections

- Easy installation with hand-tightened union nuts
- 2-way blocking ball valve
- Easy line breakdowns without installing additional unions
- Full port design minimum flow restrictions
- Manufactured/assembled without hydrocarbon lubricants
- Mounting pads for electric or pneumatic actuation
- Includes threaded and socket ends



T/S-703

| Part # | Size | List price | Case | Carton | Weight |
|---------|--------|------------|------|--------|--------|
| 210-543 | 1/2" | \$7.96 | 48 | 1 | 21 |
| 210-544 | 3/4" | \$10.27 | 36 | 1 | 25 |
| 210-545 | 1" | \$14.08 | 24 | 1 | 24 |
| 210-546 | 1-1/4" | \$20.54 | 24 | 1 | 40 |
| 210-547 | 1-1/2" | \$27.17 | 24 | 1 | 59 |
| 210-548 | 2" | \$37.28 | 12 | 1 | 51 |
| 210-549 | 2-1/2" | \$65.66 | 12 | 1 | 75 |
| 210-550 | 3" | \$104.91 | 6 | 1 | 54 |
| 210-551 | 4" | \$207.15 | 1 | 1 | 25 |

T-711 & S-711

PVC In-Line • Schedule 40 • 150 WOG

• NPS connections

- Installs horizontally or vertically
- Stainless steel spring-loaded PVC poppet
- Cracking pressure at .5 PSI



T-711

S-711

| Threaded | Solder | Size | List price | Case | Carton | Weight |
|----------|---------|--------|------------|------|--------|--------|
| 210-303 | 210-323 | 1/2" | \$4.18 | 96 | 1 | 24 |
| 210-304 | 210-324 | 3/4" | \$4.66 | 96 | 1 | 24 |
| 210-305 | 210-325 | 1" | \$6.56 | 80 | 1 | 46 |
| 210-306 | 210-326 | 1-1/4" | \$8.43 | 60 | 1 | 45 |
| 210-307 | 210-327 | 1-1/2" | \$8.88 | 60 | 1 | 56 |
| 210-308 | 210-328 | 2" | \$10.27 | 40 | 1 | 64 |

S-700

Union • Schedule 80 • 150 WOG

• NPS connections

Approvals



S-700

| Part # | Size | List price | Case | Carton | Weight |
|----------|--------|------------|------|--------|--------|
| 210-403 | 1/2" | \$1.78 | 288 | 36 | 44 |
| 210-404 | 3/4" | \$2.25 | 144 | 24 | 38 |
| 210-405 | 1" | \$2.76 | 96 | 12 | 41 |
| 210-406 | 1-1/4" | \$4.15 | 96 | 12 | 56 |
| 210-407 | 1-1/2" | \$5.45 | 64 | 8 | 49 |
| 210-408 | 2" | \$8.24 | 48 | 4 | 56 |
| 210-409 | 2-1/2" | \$13.44 | 24 | 2 | 47 |
| 210-410 | 3" | \$18.83 | 12 | 2 | 33 |
| 210-411* | 4" | \$43.02 | - | - | - |

*Special order

Dielectric Unions

Dielectric Union

Brass Solder x Galvanized • 250 PSI

- Prevents accelerated corrosion
- -20°F to 180°F - Buna Seats
- -20°F to 220°F - Teflon® Seats

| Solder x FIP | Size | List price | Case | Carton | Weight |
|--------------|--------|------------|------|--------|--------|
| 701-103 | 1/2" | \$3.77 | 144 | 12 | 48 |
| 701-104 | 3/4" | \$4.42 | 144 | 12 | 62 |
| 701-105 | 1" | \$6.28 | 72 | 12 | 41 |
| 701-106 | 1-1/4" | \$9.34 | 72 | 6 | 62 |
| 701-107 | 1-1/2" | \$13.86 | 36 | 6 | 49 |
| 701-108 | 2" | \$22.08 | 24 | 6 | 62 |

| Reducing | Size | List price | Case | Carton | Weight |
|----------|-------------|------------|------|--------|--------|
| 701-204 | 3/4" x 1/2" | \$4.31 | 144 | 12 | 62 |
| 701-205 | 1" x 3/4" | \$6.96 | 72 | 12 | 43 |

| Solder x MIP | Size | List price | Case | Carton | Weight |
|--------------|-------------|------------|------|--------|--------|
| 701-303 | 1/2" | \$5.37 | 96 | 12 | 48 |
| 701-304 | 3/4" | \$6.18 | 96 | 12 | 56 |
| 701-305 | 3/4" x 1/2" | \$5.94 | 96 | 12 | 56 |
| 701-306 | 1" | \$8.39 | 72 | 12 | 59 |



SOLDER X FIP



REDUCING



SOLDER X MIP

Dielectric Union

Black Iron FIP x FIP • 250 PSI

- Prevents accelerated corrosion
- For use on black pipe
- -20°F to 180°F - Buna seats
- -20°F to 220°F - Teflon® seats

| Part # | Size | List price | Case | Carton | Weight |
|---------|--------|------------|------|--------|--------|
| 701-403 | 1/2" | \$4.38 | 100 | 10 | 51 |
| 701-404 | 3/4" | \$5.77 | 100 | 10 | 67 |
| 701-405 | 1" | \$9.61 | 50 | 5 | 53 |
| 701-406 | 1-1/4" | \$14.40 | 40 | 5 | 57 |
| 701-407 | 1-1/2" | \$21.43 | 20 | 5 | 61 |
| 701-408 | 2" | \$34.65 | 20 | 2 | 77 |



BLACK IRON FIP X FIP

Dielectric Unions



Dielectric Union

Galvanized FIP x FIP • 250 PSI

- Prevents accelerated corrosion
- -20°F to 180°F - Buna seats
- -20°F to 220°F - Teflon® seats

| Part # | Size | List price | Case | Carton | Weight |
|---------|--------|------------|------|--------|--------|
| 701-413 | 1/2" | \$4.55 | 100 | 10 | 51 |
| 701-414 | 3/4" | \$6.05 | 100 | 10 | 67 |
| 701-415 | 1" | \$9.88 | 50 | 5 | 53 |
| 701-416 | 1-1/4" | \$14.95 | 40 | 5 | 57 |
| 701-417 | 1-1/2" | \$22.62 | 20 | 5 | 61 |
| 701-418 | 2" | \$36.52 | 20 | 2 | 77 |



GALVANIZED FIP X FIP

Dielectric Union

Brass FIP x Galvanized FIP • 250 PSI

- Prevents accelerated corrosion
- -20°F to 180°F - Buna seats
- -20°F to 220°F - Teflon® seats

| Part # | Size | List price | Case | Carton | Weight |
|---------|------|------------|------|--------|--------|
| 701-503 | 1/2" | \$6.49 | 100 | 10 | 51 |
| 701-504 | 3/4" | \$8.42 | 100 | 10 | 68 |
| 701-505 | 1" | \$13.42 | 100 | 10 | 53 |



BRASS FIP X GALVANIZED FIP

Repair Kits

BUNA-N - Gaskets for 180°F

| Copper x Female | List price | Female x Female | List price |
|-----------------|------------|-----------------|------------|
| 701-603C | \$0.20 | 701-603F | \$0.24 |
| 701-604C | \$0.24 | 701-604F | \$0.28 |
| 701-605C | \$0.28 | 701-605F | \$0.31 |
| 701-606C | \$0.31 | 701-606F | \$0.41 |
| 701-607C | \$0.41 | 701-607F | \$0.56 |
| 701-608C | \$0.56 | 701-608F | \$0.68 |
| 701-609C | \$0.95 | 701-609F | \$0.95 |

Repair Kits

Teflon - Gaskets for 220°F and Petroleum Products

| Copper x Female | Female x Female | List Price |
|-----------------|-----------------|------------|
| 702-703C | 702-703F | \$1.09 |
| 702-704C | 702-704F | \$1.33 |
| 702-705C | 702-705F | \$1.76 |
| 702-706C | 702-706F | \$2.52 |
| 702-707C | 702-707F | \$5.37 |
| 702-708C | 702-708F | \$6.90 |

Basket Strainers

Snap-N-Loc®

300 Grade Stainless/Brushed Stainless Steel Sink Strainer

| Part # | Model | Finish | List price |
|-------------|---------|----------------------------|------------|
| 300-006 | SS 306 | 300 Series Stainless Steel | \$17.16 |
| 300-008 | SS 306B | 300 Series Stainless Steel | \$21.32 |
| 300-017CLAM | BS-313B | Brushed Stainless | \$28.41 |



SS-306

Twist-N-Loc®

Chrome Plated Brass/Brushed Stainless Steel Sink Strainer

| Part # | Model | Finish | List price |
|-------------|---------|---------------------|------------|
| 300-001 | SS 304 | Chrome Plated Brass | \$24.47 |
| 300-003 | SS 304B | Chrome Plated Brass | \$29.56 |
| 300-023CLAM | BS-325B | Brushed Stainless | \$30.63 |



SS-304

Easy-Loc®

Chrome Plated Brass Sink Strainer

| Part # | Model | Finish | List price |
|---------|--------|---------------------|------------|
| 300-004 | SS 305 | Chrome Plated Brass | \$28.08 |



SS-305

Smart Move®

Chrome Plated Brass Sink Strainer

| Part # | Model | Finish | List price |
|---------|--------|---------------------|------------|
| 300-009 | SS 410 | Chrome Plated Brass | \$20.87 |



SS-410

Mag-Na-Loc®

300 Grade Stainless Steel Sink Strainer

| Part # | Model | Finish | List price |
|---------|--------|----------------------------|------------|
| 300-011 | SS 420 | 300 Series Stainless Steel | \$15.84 |



SS-420

Basket Strainers

Snap-Tite®

300 Grade Stainless Steel Sink Strainer

| Part # | Model | Finish | List price |
|---------|---------|----------------------------|------------|
| 300-012 | SS 440 | 300 Series Stainless Steel | \$11.96 |
| 300-014 | SS 440B | 300 Series Stainless Steel | \$16.16 |



SS-440

Snap-N-Seal®

300 Grade Stainless Steel Sink Strainer

| Part # | Model | Finish | List price |
|---------|-------|----------------------------|------------|
| 300-013 | SS430 | 300 Series Stainless Steel | \$9.06 |



SS-430

Push-N-Seal II®

300 Grade Brushed Stainless Steel Sink Strainer

| Part # | Model | Finish | List price |
|-------------|------------|-------------------|------------|
| 300-021CLAM | BS-323-DBS | Brushed Stainless | \$23.72 |



BS-323-DBS

Small Wonder®

Chrome Plated Brass/Brushed Stainless Steel Sink Strainer

| Part # | Model | Finish | List price |
|-------------|--------|---------------------|------------|
| 300-101 | SS 308 | Chrome Plated Brass | \$18.90 |
| 300-019CLAM | BS 315 | Brushed Stainless | \$25.44 |



SS-308

Bar-ette®

Chrome Plated Brass/Brushed Stainless Steel Sink Strainer

| Part # | Model | Finish | List price |
|-------------|--------|---------------------|------------|
| 300-102 | SS 310 | Chrome Plated Brass | \$14.49 |
| 300-020CLAM | BS 316 | Brushed Stainless | \$24.41 |



SS-310 BAR-ETTE™

Basket Strainers BUILDERS SERIES



Snap Loc 430 Grade Stainless Steel Sink Strainer



SS406

| Part # | Model | Finish | List price |
|---------|--------|---------------------|------------|
| 305-406 | SS 406 | 430 Stainless Steel | \$12.46 |

Disposer with Stopper 430 Grade Stainless Steel Sink Strainer



SS400

| Part # | Model | Finish | List price |
|---------|--------|---------------------|------------|
| 305-400 | SS 400 | 430 Stainless Steel | \$5.40 |

Twist Loc 430 Grade Stainless Steel Sink Strainer



SS404

| Part # | Model | Finish | List price |
|---------|--------|---------------------|------------|
| 305-404 | SS 404 | 430 Stainless Steel | \$13.59 |

Easy Loc 430 Grade Stainless Steel Sink Strainer



SS405

| Part # | Model | Finish | List price |
|---------|--------|---------------------|------------|
| 305-405 | SS 405 | 430 Stainless Steel | \$14.49 |

Basic Sink Strainer 430 Grade Stainless Steel Sink Strainer



SS409

| Part # | Model | Finish | List price |
|---------|-----------------|---------------------|------------|
| 305-409 | SS 409 | 430 Stainless Steel | \$10.97 |
| 305-408 | SS 409 Deep Cup | 430 Stainless Steel | \$13.24 |

Bar Sink Strainer 430 Grade Stainless Steel Sink Strainer



SS410

| Part # | Model | Finish | List price |
|---------|--------|---------------------|------------|
| 305-410 | SS 410 | 430 Stainless Steel | \$5.61 |

Accessories

Lift-N-Lock

Spring Loaded Locking Device

Fits any T-100, S-100 or JP-100

| Open & Closed | Closed Only | Size | Type | List Price |
|---------------|-------------|------------------|------|------------|
| 210-994 | 210-994C | 1/4", 3/8", 1/2" | 1 | \$22.43 |
| 210-995 | 210-995C | 3/4" | 2 | \$22.43 |
| 210-996 | 210-996C | 1", 1-1/4" | 3 | \$26.31 |
| 210-997 | 210-997C | 1-1/2", 2" | 4 | \$34.00 |
| 210-998 | 210-998C | 2-1/2", 3" | 5 | \$48.90 |
| | 210-999C | 4" | 6 | \$220.54 |



Stem Extension

2" Handle Extension

Fits any T-100, S-100 or JP-100

| Part # | Size | Type | List Price |
|---------|-----------------|------|------------|
| 230-004 | 1/4, 3/8", 1/2" | 1 | \$19.57 |
| 230-005 | 3/4" | 2 | \$21.26 |
| 230-006 | 1", 1-1/4" | 3 | \$24.92 |
| 230-007 | 1-1/2", 2" | 4 | \$34.20 |
| 230-008 | 2-1/2", 3" | 5 | \$46.18 |



Long Neck T-handle

Long Neck Handles

Fits any T-100, S-100 or JP-100

| Part # | Size | Type | List Price |
|---------|------------------|------|------------|
| 220-223 | 1/4", 3/8", 1/2" | 1 | \$3.14 |
| 220-224 | 3/4" | 2 | \$3.42 |
| 220-225 | 1", 1-1/4" | 3 | \$5.09 |



Slo-Ball Handle

270° Gear-Closing Handle

Fits any T-100, S-100 or JP-100

| Part # | Size | Type | List Price |
|---------|------------------|------|------------|
| 220-014 | 1/4", 3/8", 1/2" | 1 | \$50.55 |
| 220-015 | 3/4" | 2 | \$50.55 |
| 220-016 | 1", 1-1/4" | 3 | \$55.97 |
| 220-017 | 1-1/2", 2" | 4 | \$104.53 |



Accessories

Stem Memory Stop

View Master Memory Stop

Fits any T-100, S-100 or JP-100

| Part # | Size | Type | List Price |
|---------|------------------|------|------------|
| 220-103 | 1/4", 3/8", 1/2" | 1 | \$6.42 |
| 220-104 | 3/4" | 2 | \$7.23 |
| 220-105 | 1", 1-1/4" | 3 | \$10.56 |
| 220-106 | 1-1/2", 2" | 4 | \$16.31 |



Shown on 1" T-100

Stainless Steel Lever Handle and Nut

Fits any T-100, S-100 or JP-100

| Part # | Size | List Price |
|---------|------------------|------------|
| 220-299 | 1/4" MINI | \$4.38 |
| 220-300 | 1/4", 3/8", 1/2" | \$5.18 |
| 220-301 | 3/4" | \$6.18 |
| 220-302 | 1", 1-1/4" | \$9.51 |
| 220-303 | 1 1/2", 2" | \$16.74 |
| 220-305 | 2 1/2", 3" | \$25.20 |
| 220-306 | 4" | \$55.54 |



Yellow Lever Handle

Fits any T-100, S-100 or JP-100

| Part # | Size | List Price |
|---------|------------------|------------|
| 899-701 | 1/4", 3/8", 1/2" | \$5.04 |
| 899-704 | 3/4" | \$5.04 |
| 899-705 | 1", 1-1/4" | \$7.70 |
| 899-708 | 1 1/2", 2" | \$13.27 |
| 899-710 | 2 1/2", 3" | \$15.69 |
| 899-711 | 4" | \$52.83 |



Round 304 Stainless Steel Handle

Fits any T-100, S-100 or JP-100

| Part # | Size | List Price |
|---------|------------------|------------|
| 220-501 | 1/4", 3/8", 1/2" | \$9.04 |
| 220-504 | 3/4" | \$12.55 |
| 220-505 | 1", 1-1/4" | \$13.51 |
| 220-508 | 1 1/2", 2" | \$14.03 |
| 220-510 | 2 1/2", 3" | \$19.16 |
| 220-511 | 4" | \$20.88 |



Accessories



Red Aluminum T-handle

Fits any T-100, S-100 or JP-100

| Part # | Size | Type | List Price |
|---------|------------------|------|------------|
| 220-204 | 1/4", 3/8", 1/2" | 1 | \$3.71 |
| 220-205 | 3/4" | 2 | \$5.04 |
| 220-206 | 1", 1-1/4" | 3 | \$7.70 |



Red Aluminum Lever Handle

Fits any T-100, S-100 or JP-100

| Part # | Size | Type | List Price |
|---------|------------------|------|------------|
| 220-114 | 1/4", 3/8", 1/2" | 1 | \$3.71 |
| 220-115 | 3/4" | 2 | \$5.04 |
| 220-116 | 1", 1-1/4" | 3 | \$7.70 |
| 220-117 | 1-1/2", 2" | 4 | \$13.27 |



Square Head Top

Fits any T-100 or S-100

| Part # | Size | List Price |
|---------|------------|------------|
| 899-113 | 1/2" | \$21.21 |
| 899-114 | 3/4" | \$21.21 |
| 899-115 | 1", 1-1/4" | \$22.16 |
| 899-117 | 1-1/2", 2" | \$24.40 |



Mufflers and Locks for Pneumatic Valves

| Part # | Size | List Price |
|-----------|-----------------|------------|
| 100-921CM | CONE MUFFLER | \$2.71 |
| 100-921FM | FLAT MUFFLER | \$2.06 |
| 100-921SL | MASTER LOCK 420 | \$23.24 |



Pressure Temperature Port

| Water Use Only (Nordel Core) | Gas Use Only (Neoprene Core) | Size | List Price |
|---------------------------------|---------------------------------|------|------------|
| 161-100 | 161-100NEO | 1/8" | \$7.51 |
| 161-101 | 161-101NEO | 1/4" | \$7.51 |



Accessories

Locking Handle for T-SS-1001VB

Fits an T-SS-1001VB

| Part # | Size | List Price |
|-----------|-----------|------------|
| 899-713VB | 1/4"-1/2" | \$5.94 |
| 899-714VB | 3/4" | \$9.18 |
| 899-715VB | 1"-1-1/4" | \$13.65 |
| 899-717VB | 1 1/2"-2" | \$20.35 |
| 899-719VB | 2 1/2"-3" | \$45.65 |



Locking Handle for T-SS-2002N-DUE

Fits an T-SS-2002N-DUE

| Part # | Size | List Price |
|-----------|--------|------------|
| 100-991LH | 1/4" | \$15.13 |
| 100-992LH | 3/8" | \$15.13 |
| 100-993LH | 1/2" | \$15.13 |
| 100-994LH | 3/4" | \$17.94 |
| 100-995LH | 1" | \$17.94 |
| 100-996LH | 1-1/4" | \$21.18 |
| 100-997LH | 1-1/2" | \$21.18 |
| 100-998LH | 2" | \$25.60 |



NEW

Round Handle for Low Pressure Valves

Fits any T-300, S-300, T-600 or S-600

| Part # | Size | List Price |
|---------|-----------|------------|
| 899-304 | 1/2"-3/4" | \$1.11 |
| 899-305 | 1" | \$1.60 |
| 899-306 | 1-1/4" | \$1.33 |
| 899-307 | 1-1/2" | \$1.62 |
| 899-308 | 2" | \$2.62 |
| 899-309 | 2-1/2" | \$3.61 |
| 899-310 | 3" | \$4.09 |
| 899-311 | 4" | \$5.23 |



Cross Handle for T-301

| Part # | Size | List Price |
|---------|----------------------|------------|
| 103-413 | FITS 1/2" & 3/4" | \$2.90 |
| 103-415 | FITS 1" | \$2.90 |
| 103-416 | FITS 1-1/4" & 1 1/2" | \$2.90 |
| 103-417 | FITS 2" | \$2.90 |
| 103-418 | FITS 2 1/2" | \$5.56 |
| 103-419 | FITS 3" | \$5.56 |
| 103-420 | 4" | \$5.56 |



Accessory Parts for T-302

| Nut | Size | List Price |
|---------|------|------------|
| 899-319 | 1/2" | \$1.52 |
| 899-321 | 3/4" | \$2.19 |
| 899-323 | 1" | \$3.19 |



| Ring | Size | List Price |
|---------|------|------------|
| 899-320 | 1/2" | \$1.52 |
| 899-322 | 3/4" | \$2.19 |
| 899-324 | 1" | \$3.19 |



Accessories



Jo-Flo Stem Extension

Fits any JF-100T/S, T/S-110, T-100HF, S-100HS, C-402, T/S-412

| Part # | Size | T/S-412 Size | List Price |
|-----------|-------------|--------------|------------|
| 100-103EH | 1/4" - 1/2" | 1/2" - 3/4" | \$4.33 |
| 100-105EH | 3/4" - 1" | 1" | \$7.32 |
| 100-108EH | 1-1/4" - 2" | - | \$8.99 |



Jo-Flo Locking Handle

Fits any JF-100T/S, T/S-110, T-100HF, S-100HS, C-402, T/S-412

| Part # | Size | T/S-412 Size | List Price |
|-----------|-------------|--------------|------------|
| 100-103LL | 1/4" - 1/2" | 1/2" - 3/4" | \$1.66 |
| 100-105LL | 3/4" - 1" | 1" | \$1.76 |
| 100-108LL | 1-1/4" - 2" | - | \$2.12 |



Jo-Flo Stainless Steel Handle and Nut

Fits any JF-100T/S, T/S-110, T-100HF, S-100HS, C-402, T/S-412

| Part # | Size | T/S-412 Size | List Price |
|-----------|-------------|--------------|------------|
| 100-103SH | 1/4" - 1/2" | 1/2" - 3/4" | \$7.13 |
| 100-105SH | 3/4" - 1" | 1" | \$9.51 |
| 100-108SH | 1-1/4" - 2" | - | \$11.89 |



Jo-Flo Lever Handles

Fits any JF-100T/S, T/S-110, T-100HF, S-100HS, C-402, T/S-412

| Part # | Size | T/S-412 Size | List Price |
|-----------|-------------|--------------|------------|
| 100-103RH | 1/4" - 1/2" | 1/2" - 3/4" | \$0.66 |
| 100-105RH | 3/4" - 1" | 1" | \$0.97 |
| 100-108RH | 1-1/4" - 2" | - | \$1.40 |
| 100-109RH | 2-1/2" | - | \$6.93 |
| 100-110RH | 3" | - | \$8.37 |
| 100-111RH | 4" | - | \$8.66 |



Jo-Flo T-handle

Fits any JF-100T/S, T/S-110, T-100HF, S-100HS, C-402, T/S-412

| Part # | Size | T/S-412 Size | List Price |
|-----------|------------------|--------------|------------|
| 100-103TH | 1/4", 3/8", 1/2" | 1/2" - 3/4" | \$1.66 |
| 100-105TH | 3/4", 1" | 1" | \$1.76 |
| 100-108TH | 1-1/4", 1 1/2" | - | \$1.84 |



Flexible Hose Connectors

| Part # | Size | List Price |
|-----------|-----------------------|------------|
| HC-AMM-12 | 1/2" x 12" HOSE MIP | \$17.32 |
| HC-AMC-12 | 1/2" x 12" HOSE SWT | \$17.15 |
| HC-AMM-18 | 1/2" x 18" HOSE MIP | \$19.19 |
| HC-AMC-18 | 1/2" x 18" HOSE SWT | \$19.02 |
| HC-AMM-24 | 1/2" x 24" HOSE MIP | \$21.43 |
| HC-AMC-24 | 1/2" x 24" HOSE SWT | \$21.26 |
| HC-AMM-36 | 1/2" x 36" HOSE MIP | \$26.02 |
| HC-AMC-36 | 1/2" x 36" HOSE SWT | \$25.88 |
| HC-BMM-12 | 3/4" x 12" HOSE MIP | \$27.07 |
| HC-BMC-12 | 3/4" x 12" HOSE SWT | \$29.86 |
| HC-BMM-18 | 3/4" x 18" HOSE MIP | \$30.33 |
| HC-BMC-18 | 3/4" x 18" HOSE SWT | \$33.12 |
| HC-BMM-24 | 3/4" x 24" HOSE MIP | \$34.48 |
| HC-BMC-24 | 3/4" x 24" HOSE SWT | \$37.26 |
| HC-BMM-36 | 3/4" x 36" HOSE MIP | \$41.41 |
| HC-BMC-36 | 3/4" x 36" HOSE SWT | \$44.19 |
| HC-CMM-12 | 1" x 12" HOSE MIP | \$50.82 |
| HC-CMC-12 | 1" x 12" HOSE SWT | \$53.40 |
| HC-CMM-18 | 1" x 18" HOSE MIP | \$55.40 |
| HC-CMC-18 | 1" x 18" HOSE SWT | \$58.12 |
| HC-CMM-24 | 1" x 24" HOSE MIP | \$59.55 |
| HC-CMC-24 | 1" x 24" HOSE SWT | \$62.13 |
| HC-CMM-36 | 1" x 36" HOSE MIP | \$69.84 |
| HC-CMC-36 | 1" x 36" HOSE SWT | \$72.42 |
| HC-DMM-18 | 1-1/4" x 18" HOSE MIP | \$88.76 |
| HC-DMC-18 | 1-1/4" x 18" HOSE SWT | \$93.17 |
| HC-DMM-24 | 1-1/4" x 24" HOSE MIP | \$97.93 |
| HC-DMC-24 | 1-1/4" x 24" HOSE SWT | \$102.38 |
| HC-DMM-36 | 1-1/4" x 36" HOSE MIP | \$114.78 |
| HC-DMC-36 | 1-1/4" x 36" HOSE SWT | \$119.23 |
| HC-EMM-18 | 1 1/2" x 18" HOSE MIP | \$152.89 |
| HC-EMC-18 | 1 1/2" x 18" HOSE SWT | \$149.15 |
| HC-EMM-24 | 1 1/2" x 24" HOSE MIP | \$164.27 |
| HC-EMC-24 | 1 1/2" x 24" HOSE SWT | \$160.50 |
| HC-EMM-36 | 1 1/2" x 36" HOSE MIP | \$178.94 |
| HC-EMC-36 | 1 1/2" x 36" HOSE SWT | \$175.17 |
| HC-FMM-24 | 2" x 24" HOSE MIP | \$273.10 |
| HC-FMC-24 | 2 X 24 HOSE SWT | \$278.51 |
| HC-FMM-36 | 2" x 36" HOSE MIP | \$316.75 |
| HC-FMC-36 | 2" x 36" HOSE SWT | \$322.12 |



FLEXIBLE HOSES

Filterball Replacement Filters 304 Stainless Steel

| Mesh 20 | Size | List Price |
|---------|-----------|------------|
| 221-014 | 1/2"-3/4" | \$12.84 |
| 221-015 | 1" | \$14.31 |
| 221-016 | 1-1/4" | \$16.55 |
| 221-017 | 1 1/2" | \$19.16 |
| 221-018 | 2" | \$29.39 |

| Mesh 40 | Size | List Price |
|---------|-----------|------------|
| 221-114 | 1/2"-3/4" | \$14.17 |
| 221-115 | 1" | \$15.79 |
| 221-116 | 1-1/4" | \$18.36 |
| 221-117 | 1 1/2" | \$21.30 |
| 221-118 | 2" | \$32.67 |

| Mesh 60 | Size | List Price |
|---------|-----------|------------|
| 221-204 | 1/2"-3/4" | \$25.63 |
| 221-205 | 1" | \$28.77 |
| 221-206 | 1-1/4" | \$32.67 |
| 221-207 | 1 1/2" | \$38.28 |
| 221-208 | 2" | \$59.11 |

| Mesh 80 | Size | List Price |
|---------|-----------|------------|
| 221-214 | 1/2"-3/4" | \$28.01 |
| 221-215 | 1" | \$31.58 |
| 221-216 | 1-1/4" | \$36.09 |
| 221-217 | 1 1/2" | \$41.94 |
| 221-218 | 2" | \$64.82 |

| Mesh 100 | Size | List Price |
|----------|-----------|------------|
| 221-224 | 1/2"-3/4" | \$29.39 |
| 221-225 | 1" | \$32.91 |
| 221-226 | 1-1/4" | \$37.66 |
| 221-227 | 1 1/2" | \$43.99 |
| 221-228 | 2" | \$67.81 |

Oxygen Cleaning

Oxygen cleaning is the thorough removal of hydrocarbons (typically a grease or oil type substance) and other readily oxidizable materials from valves, fittings, and pipes, and for use in medical oxygen services.

NFPA 99C states materials for use in medical gas piping must be cleaned, plugged, capped and bagged until installed.

Ultrasonic energy causes alternating patterns of low and high pressure phases. During the low pressure phase, min-

ute bubbles or vacuum cavities form. During the subsequent high pressure phase, the bubbles implode violently. This is called cavitation.

Cavitation provides an intense scrubbing action that leads to unsurpassed cleaning speed and consistency. These bubbles are small enough to penetrate even microscopic crevices, cleaning them thoroughly and consistently and resulting in one of the most highly effective and efficient methods of oxygen cleaning.



Private Label

Jomar offers custom valve branding to help you promote your business!

Guidelines:

- One time artwork set up fee
- Additional per valve net charge
- Minimum of 250 pieces – any combination of sizes
- High resolution artwork to be supplied by customer
- Additional fees may apply to orders under the piece minimum
- All Jomar warranties and certifications still apply

Options:

- All Valves come with a yellow handle
- Available Ink Colors – Black and Green
- Digital proof to be approved prior to first order
- Orders shipped within 10 business days – based on availability of valves



E-Commerce

Jomar is pleased to announce that we have just launched our new e-Commerce website! Our newly designed site will enable you 24/7 access to check the status of your orders, view your invoice history, check pricing and availability, and place orders online—all at your own convenience! In addition, there will be Jomar specials and offers found exclusively on our website.

To register, visit www.jomarvalve.com/ecom and fill out a simple registration form, or call us today, and we will be happy to register you over the phone.

If you have any questions at all, please don't hesitate to call us at (800) 325-5690 or get Live Chat help at www.jomarvalve.com.



Electronic Data Interchange (EDI)

Allowing customers to electronically transmit orders from their system at any given moment, EDI reduces the amount of time it takes to process orders. EDI eliminates the waiting for acknowledgements, paying for costly errors, and endless amounts of paper work and manual labor. Fulfilling your order quickly and on time, EDI offers the flexibility and functionality that you deserve.

With Jomar EDI, you can transmit the following documents:

- 810 - Invoice
- 850 - Purchase Order
- 855 - Purchase Order Acknowledgement
- 856 - Advance Ship Notice

Instant. Accurate. Efficient. Jomar EDI is the better way to do business.

TERMS AND CONDITIONS OF SALE

UNLESS OTHERWISE SPECIFIED IN WRITING THE FOLLOWING WILL PREVAIL

GENERAL

The possession of the Jomar International catalog and/or literature is not to be construed as an offer to sell the goods listed herein. All orders shall be subject to the approval and acceptance of Jomar International, hereinafter referred to as the Company, at its principal office in Warren, Michigan.

All Company proposals, all acceptances of Purchaser's orders, and all sales by the Company are expressly limited to, and expressly made conditional upon, the Purchaser's acceptance and assent to the Standard Terms and Conditions of Sale as set forth herein, notwithstanding receipt of, or acknowledgment of, the Purchaser's order form or specifications containing additional or different provisions, or conflicting oral representations by any agent or employee of the Company. No waiver, change or modification of any terms or conditions on the face or reverse hereof shall be binding on the Company unless made in writing and signed by an officer of the Company.

PRICES AND TERMS

All prices are subject to change without notice. Minimum billing is \$50.00. Terms are 2% 10 days, NET 30 days subject to approved credit. Not applicable to credit card payments. Shipments can be expected, prior to establishing credit, by including check with order for full amount or specifying C.O.D.

Any order originating outside the contiguous United States, Alaska, Hawaii or Canada shall be subject to an irrevocable letter of Credit confirmed by a U.S. bank or a sight draft.

1-1/2% per month service charge on all balances unpaid by the 1st of the following month (18% annual interest rate).

PERFORMANCE GUARANTEE

The Company guarantees to the original purchaser that the equipment of its manufacture will perform at rated capacity as stated only when (1) properly installed, connected, started, operated and maintained in accordance with Company Instruction(s), and/or Information Guide(s), as revised from time to time, and (2) used for the applications specified and (3) used in the environments as specified or as limited. If equipment is part of a greater system, the Company accepts responsibility only for the equipment manufactured by it.

THIS EQUIPMENT MUST BE INSTALLED, OPERATED, AND MAINTAINED IN ACCORDANCE WITH THE APPROPRIATE INSTRUCTIONS(S) AND/OR INFORMATION GUIDE(S), AS REVISED FROM TIME TO TIME, PURCHASERS OF THE COMPANY'S EQUIPMENT WAIVE SUBROGATION ON ALL ITEMS COVERED UNDER THEIR OWN OR OTHER INSURANCE.

LIMITED WARRANTY ON THE EQUIPMENT ITSELF

The Company, for a period of one year from the date of shipment, warrants each product or system of its own manufacture to the original purchaser to be free from defects in material and workmanship under normal use, service and maintenance. Normal use, service and maintenance means:

- Not in excess of the maximum pressures, temperatures, volumes and rated capacities or other parameters specified in the Company's Product Bulletins, Specification Sheets, and/or quotation(s).
- Using only fluids specified in the Company's Product Bulletins, Specification Sheets, and/or quotations.
- Operation and maintenance in compliance with the appropriate instructions and/or Information Guides.

FREIGHT ALLOWANCE

All prices are FOB Warren, Michigan with full freight prepaid and allowed within the contiguous United States on shipments of \$1,500.00 net or more excluding ductile/cast iron, stainless steel and carbon steel products which are \$2,500.00 or more. Any combination of products, items or sizes may be combined to satisfy the dollar amount required to earn full freight allowance. The Company reserves the right to select the most economical routing and shall not be liable or responsible by reason of the mode or route of shipment.

EXPORT SHIPMENTS

All prices are FOB plant, Warren, Michigan, with full freight prepaid and allowed to Port of Exit on shipments of \$1,500.00 net or more.

PACKAGING

All list prices are based on domestic packaging. For export packaging, contact the factory for pricing.

DELIVERY

The quoted time of delivery is understood to be from date of receipt of all necessary information including Purchaser's approval, if applicable. Any delay in delivery of any installment shall not relieve purchaser of its obligation to accept remaining deliveries. The Company shall not be liable for damages or for cancellation of the contract as a result of any delay due to any cause beyond the Company's reasonable control including, but not limited to, act of God, act of the purchaser, embargo or other governmental acts, regulations or requirements, fire accident, labor disputes, war, civil insurrection or riot, delay in transportation or the inability to obtain necessary labor, materials or manufacturing facilities. In the event of any such delay the date of delivery shall be extended for a period equal to the time lost by reason of the delay. All shipments, unless otherwise specified, shall be FOB shipping point and the purchaser assumes responsibility for damage or loss in transit. The Company shall not be liable or responsible by reason of the mode or route of shipment.

Products or goods not of Company manufacture supplied in piece, or as components to a system designed or sold by the Company, are not covered by this warranty. However, the Company will extend to the purchaser the benefit of such adjustment as is obtained from the manufacturer of that component or product.

This warranty does not apply to damage caused by any or all of the following circumstances or conditions:

- Freight damage.
- Parts and/or accessories or components not obtained from or approved by the Company.
- Any consequential or incidental damage arising from the use of the product, system or other goods manufactured or sold by the Company.
- Misapplication, misuse, abuse, or failure to follow the Product Instruction Sheets and/or Information Guides

The remedy under this warranty is limited to the repair or replacement of any parts found upon examination by the Company to have been defective, and shall not include removal and reinstallation costs involved in the exchange. The remedy shall be conditioned upon receipt of written notice by the Company of any alleged defects promptly after discovery thereof within the warranty period. Generally, consent, if given, will be upon the condition that the purchaser assumes and prepays all carrier charges.

THIS WARRANTY IS EXCLUSIVE. THE COMPANY EXPRESSLY DISCLAIMS ANY AND ALL OTHER WARRANTIES, WHETHER EXPRESSED OR IMPLIED, INCLUDING ANY IMPLIED WARRANTY OR MERCHANT ABILITY OF FITNESS FOR A PARTICULAR PURPOSE OR, ANY PURPOSE.

No person, including any dealer or representative of the Company, is authorized to make any representations concerning the Company products or systems on behalf of the Company or to assume for the Company the obligations contained in this warranty. The Company reserves the right to make design and other changes, modifications or improvements upon its products or systems, without any obligation to install same on any previously sold or delivered products or systems.

This warranty gives the purchaser specific legal rights. The purchaser may have other rights that vary from state to state.

LIMITATION OF LIABILITY

It is expressly agreed that the liability is limited and the Company does not function as an insurer. The purchaser and/or user agree that the Company is not liable for loss, harm or damage due directly or indirectly to any occurrence of consequence therefrom. If the Company should be found liable to anyone in any theory (except any express warranty where the remedy is set forth in this document) for loss, harm, or damage, the liability of the Company shall be limited to the lesser of the actual loss, harm or damage, or the original purchase price of the involved equipment, system or service when sold (or when services performed by) the Company to its customer. This liability is exclusive and regardless of cause or origin resulting directly or indirectly to person or property from:

- The performance or non-performance of any obligation set forth in this warranty and warranty policy.
- Any agreement, oral or written, including specifications, between the Company and the customer.
- Negligence, active, passive or otherwise, of the Company or any of its agents, employees, or independent contractors.
- Breach of any judicially imposed warranty or covenant and,
- Misrepresentation or strict liability involvement.

SPECIAL PRODUCTS

Special products produced to order, or products not normally stocked, are subject to a 10% overrun or underrun. Pattern equipment, tooling, etc., built for the manufacture of purchaser's products shall at all times remain in the possession of the Company. Since such equipment is made or supplied on a non-profit basis, it shall not be removed from the Company's plant except upon payment of a minimum 20% charge: based on the original equipment costs to cover engineering, drafting, and handling. The Company agrees to maintain such equipment except the major repairs or replacement would be at the purchaser's expense. If no orders have been received for production for a period of eighteen months, the Company accepts no liability for the continued existence or availability of such equipment after such period. Written notification advising the customer of the expiration date will not be required of the Company.

BUYER'S PURCHASE ORDER TERMS

The terms on the purchase order shall not change, enlarge, or modify Company's liability or obligations.

SHORTAGE AND BREAKAGE

The Company's responsibility for delivery of materials sold FOB shipping point ends when the receipt is obtained from the consignor of the transportation company. It is agreed that the purchaser shall notify the Company of any shortage within five (5) days from receipt of the material. In the event of loss or damage incurred in transit, the carrier shall be responsible and claims for parts broken or lost in shipment are to be filed with the transportation company by the company.

CANCELLATION OF ORDERS

If, for any reason, the purchaser desires to cancel an order, such cancellation shall only be with written consent of the Company, and then only after payment is made to the Company for all costs incurred which shall include but not be limited to, material, labor, overhead, and reasonable profit.

RETURNS AND RESTOCKING CHARGES

Equipment may be returned to Jomar International at 7243 Miller Drive, Warren, Michigan 48092, only upon prior written authorization of the Company. Consent, if given, will be upon the condition the purchaser assumes all carrier charges responsibility for damages in transit, and a minimum 15% restocking charge, and then only if the so authorized material is in new and unused condition and returned within one year from the original date of shipment. The credit will be based on the original invoice price or the current price, whichever is lower, less the applicable restocking charge.

SERVICE

Unless otherwise noted herein, the cost of the equipment does not include service or installation. All services performed by the Company are subject to purchaser's payment of the Company's prevailing charges plus necessary travel and living expense.

TAXES

Any tax or taxes that may be imposed upon the goods that are the subject of this sale, or upon the sale or delivery, shall be added to and become a part of the contract price.

REGULATIONS

Every contract of sale shall be subject to all applicable state and federal statutes and regulations.

The terms of this agreement shall be construed in accordance with the laws of the state of Michigan.



① Jomar Group Headquarters

7243 Miller Dr., Warren, MI 48092
Phone: (586) 268-1220 / Fax: (586) 979-8315

② Specification Sales

1295 E. Acacia Street, Ontario, CA 91761
Phone: (909) 594-7088 / Fax: (909) 594-2798

③ NorPac, Inc.

20015 85th Avenue South, Kent, WA 98031
Phone: (253) 850-8800 / Fax: (253) 850-7872

④ Stephen & Stephenson

4626 Windfern, Houston, TX 77041
Phone: (713) 227-7254 / Fax: (713) 227-4946

⑤ Bennerotte Marketing Agency

14332 21st Avenue, Suite 200, Plymouth, MN 55447
Phone: (763) 544-8611 / Fax: (763) 544-7084

⑥ ITM

6520 Viscount Road, Mississauga, Ontario L4V 1H3,
Phone: (905) 612-0400 / Fax: (905) 673-8788

⑦ WB & Associates

225 Clanton Rd., Charlotte, NC 28147
Phone: (704) 527-5550 / Fax: (704) 527-4921

⑧ CK Dorman

1127 West 8th Street, Kansas City, MO 64101
Phone: (816) 421-5988 / Fax: (816) 842-3562

⑨ Braswell & Associates

3243 Garden Brook Drive, Farmers Branch, TX 75234
Phone: (972) 713-7465 / Fax: (972) 713-6424

⑩ Bradford Sales

2700 Bankers Industrial Drive, Atlanta, GA 30360
Phone: (770) 448-3400 / Fax: (770) 448-5107

⑪ NEO Valves

51 Terecar Drive - Unit #2, Vaughan, Ontario L4L 0B5
Phone: (905) 264-6556 / Fax: (905) 264-8445

⑫ NEO Valves

23-1610 Derwent Way, Delta, BC, Canada V3M 6W1
Phone: 905-264-7098

⑬ Paramount

7650 Marathon Dr. Suite F, Livermore, CA 94550
Phone: (925) 373-0817 / Fax: (925) 373-1048

⑭ Southwestern Mechanical Sales

3191 Builders Ave., Las Vegas, NV 89101
Phone: (702) 368-2561 / Fax: (702) 368-1784

⑮ Southwestern Mechanical Sales

4771 S. Overland Dr., Tucson, AZ. 85714
Phone: (520) 884-1414 / Fax: (520) 884-4797

⑯ Pinnacle Marketing

4400 2nd Street NW, Albuquerque, NM. 87107
Phone (505) 345-2700 / Fax: (505) 345-0700



T-100NEG

7243 Miller Drive • Warren, MI 48092
phone: (586) 268-1220 • fax: (586) 979-8315 • email: csr@jomar.com
www.jomarvalve.com